

RAHS200-110B24-Y DC-DC Converter

Input 43V~160V, Output 24V/8.33A

Contents

Features.....	1
Ordering Information.....	1
Outline Diagram& AI baseplate+Terminals.....	2
Specifications.....	3
Characteristic Curves.....	5
Design Considerations.....	6
Basic Connection.....	6
Input Voltage Range.....	6
External Capacitance.....	6
Remote Control.....	7
Output Voltage Adjust.....	7
Remote Sense.....	7
Output Over Voltage Protection(OVP).....	8
EMC Solution.....	8
Thermal Consideration.....	8
Safety Consideration.....	9
Product Installation.....	9
ESD Control.....	9
Cleaning Notice.....	9
Delivery Package Information.....	9
Quality Statement.....	9
Contact Information.....	9



*Converter RAHS200-110B24-Y
Chassis mount package*

Features

- ◆ Half-brick with Terminals and AI baseplate (85.0mm×61.0mm×29.7mm)
- ◆ Positive Logic Control (3.5V to 15V turn on)
- ◆ Input Under voltage Protection
- ◆ Output Over Voltage Protection (OVP)
- ◆ Output Voltage Adjust Range:±10 % of the rated output voltage
- ◆ Output Short-circuit Protection, hiccup, auto-recovery
- ◆ High efficiency up to 90%(110V,full load)
- ◆ 1500Vac Isolation Voltage
- ◆ Operating Ambient Temperature: (-40°C to +85°C)
- ◆ Over Temperature Protection: 110°C Typ.
- ◆ Meets requirements of Standard EN50155
- ◆ Application: Industrial electronics & control and Rail transit & railway application

Ordering Information

See Contents for individual product ordering numbers.

Suffix	Meaning	Ordering Model
--	Basic Model	RAHS200-110B24-Y
P	Negative Logic Control. Turn off when CNT pin is applied to 3.5~15V voltage or kept floating; Turn on when CNT pin is applied to 0~1.5V voltage	RAHS200-110B24P-Y

RAHS200-110B24-Y DC-DC Converter

Input 43V~160V, Output 24V/8.33A

Outline Diagram& AI baseplate+Terminals

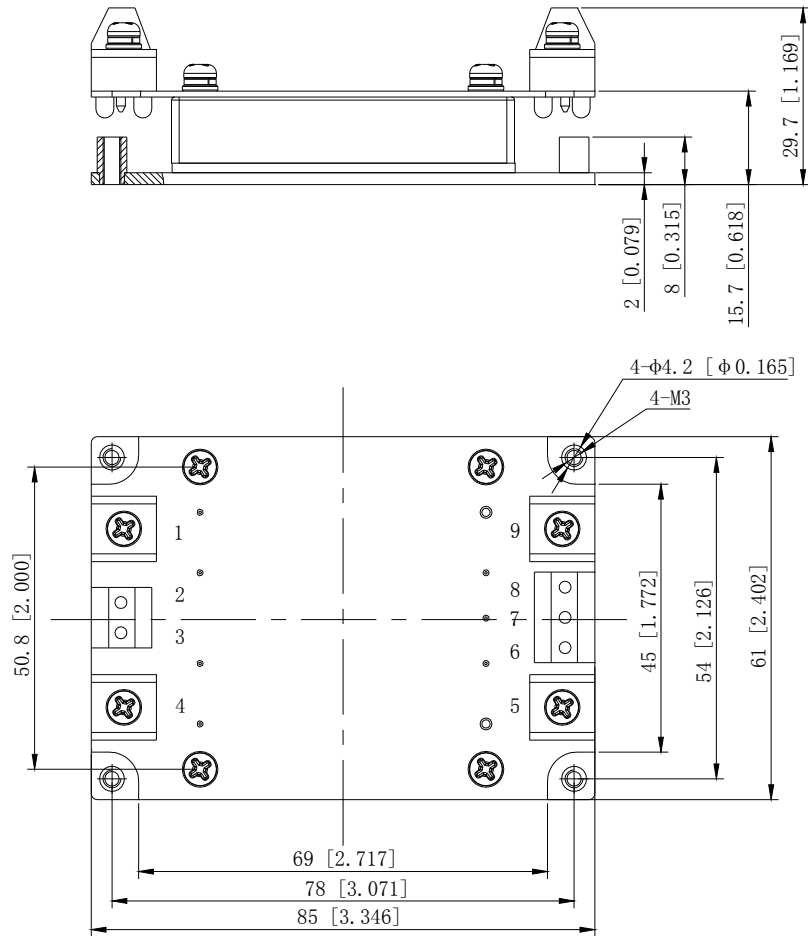

Case material: Black flame retardant Plastic; Pins: copper with gold plating
 Aluminum baseplate can be connected to Protective Earth pin by M3 screw.

Notes: all dimensions in mm[inches]

Tolerances: X.X±0.5mm[X.XX±0.02] X.XX±0.25mm[X.XXX±0.010]

Pin definition:		
Pin	Symbol	Function
1	-Vin	Negative Input
2	CASE	Connect to the baseplate
3	CNT	Remote Control, turn on/off the converter without cutting off the power supply
4	+Vin	Positive Input
5	+Vo	Positive output
6	+S	Positive Remote Sense, connected to +Vo pin when not in use
7	TRIM	Output Voltage Trim, voltage be trimmed up or down by applying external resistor connected to +S or -S output
8	-S	Negative Remote Sense, connected to -Vo pin when not used.
9	-Vo	Negative Output

RAHS200-110B24-Y DC-DC Converter

Input 43V~160V, Output 24V/8.33A

Specifications

Unless otherwise specified, all tests are at room temperature and standard atmosphere pure resistive load and basic connection.

Input	Symbol	Min	Typ	Max	Unit	Conditions	
Input Voltage	V_{in}	43	110	160	V	—	
Maximum Input Current	$I_{in,max}$	—	—	5.8	A	—	
Positive Logic Remote Control	ON	—	3.5	—	15.0	V	Refer to $-V_{in}$; Also turn on when CNT floating
	OFF	—	0	—	1.5	V	
	Current	—	—	—	1	mA	CNT source current when turn on
Negative Logic Remote Control	ON	—	0	—	1.5	V	Refer to $-V_{in}$; Also turn on when CNT links to $-V_{in}$
	Current	—	—	—	5.0	mA	CNT source current when turn on
	OFF	—	3.5	—	15.0	V	Refer to $-V_{in}$; Turn off when CNT floating
	Current	—	—	—	5.0	mA	CNT sink current when turn off
Under Voltage Threshold	V_{UVLO}	32	—	41	V	—	

Output	Symbol	Min	Typ	Max	Unit	Conditions	
Output Power	P_o	0	—	200	W	—	
Output Voltage	V_o	23.76	24.00	24.24	V	—	
Output Current	I_o	—	8.33	—	A	—	
Output Voltage Adjust Range	V_{trim}	21.6	—	26.4	V	$I_o \leq 8.33A, P_o \leq 200W$	
Remote Sense Compensation Range	V_{sense}	—	—	0.5	V	—	
Line Regulation	S_V	—	—	± 0.2	% V_o	$V_{in}: 43V \sim 160V, I_o \leq 8.33A$	
Load Regulation	S_I	—	—	± 0.5	% V_o	$V_{in}: 110V, I_o = 0A \sim 8.33A$	
Capacitive Load Range	C_o	0	—	2000	μF	Pure resistive load	
Output Overshoot	V_{TO}	—	—	10	% V_o	Pure resistive load	
OVP Set Point	$V_{ov,set}$	28.8	—	33.6	V	—	
Current Limit Inception	$I_{o,lim}$	9.2	—	16.7	A	—	
Output Short-circuit Protection	Hiccup mode, automatic recovery						
Peak to Peak Ripple and Noise	ΔV_{pp}	—	—	200	mV	20MHz bandwidth, Output equipped 10 μF tantalum capacitor and 1 μF ceramic capacitor	
Load Transient	Recovery Time	t_{tr}	—	—	400	μs	Load change: 25%~50%~25% & 50%~75%~50% Current change: 0.1A/ μs
	Voltage Deviation	ΔV_{tr}	—	—	± 960	mV	

RAHS200-110B24-Y DC-DC Converter

Input 43V~160V, Output 24V/8.33A

General	Symbol	Min	Typ	Max	Unit	Conditions
Efficiency	η	—	90	—	%	V_{in} : 110V, $I_o \leq 8.33A$
Switching Frequency	f_s	—	250	—	kHz	—
Isolation Resistance	R_{iso}	50	—	—	M Ω	Under normal atmospheric pressure, Relative humidity:90%, Test voltage:500Vdc
Isolation Voltage	V_{iso}	1500	—	—	V _{ac}	Input to output Leak Current: 10mA
		1500	—	—	V _{ac}	Input to case Leak Current: 10mA
		1500	—	—	V _{ac}	Output to case Leak Current: 10mA
Operating Baseplate Temperature	—	-40	—	100	°C	—
Operating Ambient Temperature	—	-40	—	85	°C	See Natrual Cooling Derating
OTP Set Point	T_{ref}	—	110	—	°C	Baseplate Temperature
Storage Temperature	—	-55	—	125	°C	—
Temperature Coefficient	S_T	—	—	± 0.02	%/°C	—
MTBF	—	—	2×10^6	—	h	BELLCORE TR-332
Shock and Vibration	Meets EN50155					
Weight	—	—	140	—	g	—

EMC SPECIFICATIONS	Conditions	Level
EMI Conducted emission	EN55032	CLASS A(See Page 8)
Fast transient/burst immunity	IEC/EN61000-4-5 line to line($\pm 1kV/2\Omega$); GB/T 17626.5 line to ground($\pm 2kV/12\Omega$)	Perf. Criteria B(See Page 8)
Surge immunity	IEC/EN61000-4-4 $\pm 2kV(5/50ns, 5kHz)$ GB/T 17626.4	Perf. Criteria A(See Page 8)

RAHS200-110B24-Y DC-DC Converter

Input 43V~160V, Output 24V/8.33A

Characteristic Curves

Load Transient Response

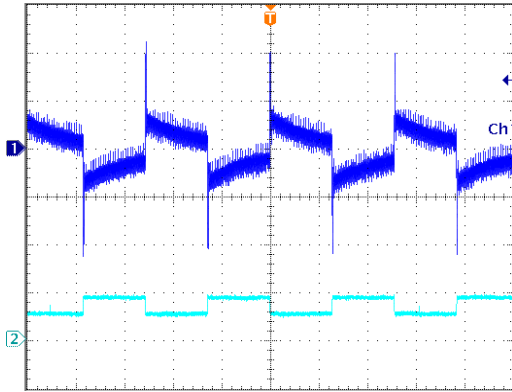

Load change: 25%~50%
 ~25% $I_{o,max}$, 0.1A/ μ s
 V_{in} =110Vdc
 Trace1: 200mV/div
 Trace2: 6A/div
 Time scale: 4ms/div

Load Transient Response

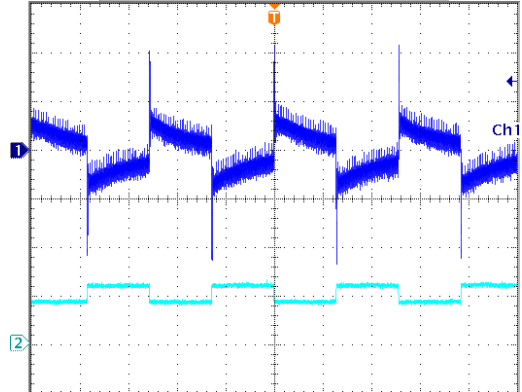

Load change: 50~75%
 ~50% $I_{o,max}$, 0.1A/ μ s
 V_{in} =110Vdc
 Trace1: 200mV/div
 Trace2: 6A/div
 Time scale: 4ms/div

Output Ripple and noise

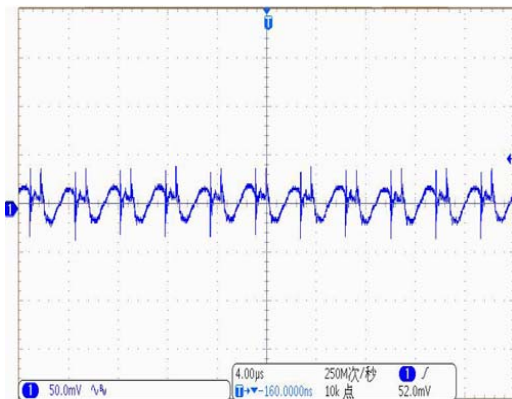

V_{in} =110Vdc, I_o =8.33A (20MHz)

Start-up Delay Time

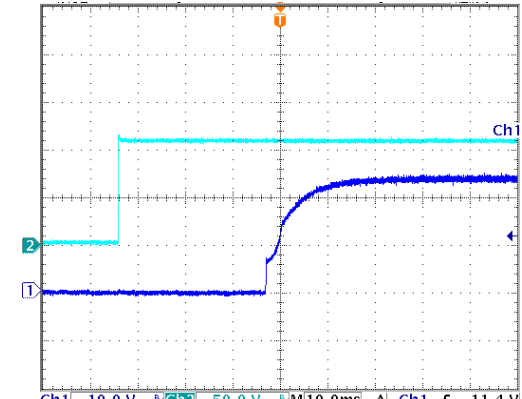

V_{in} =110Vdc, I_o =8.33A (20MHz)

Rise Time

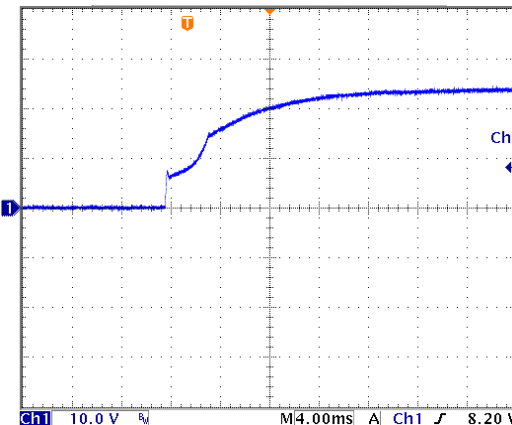

V_{in} =110Vdc, I_o =8.33A (20MHz)

Efficiency vs Load Current

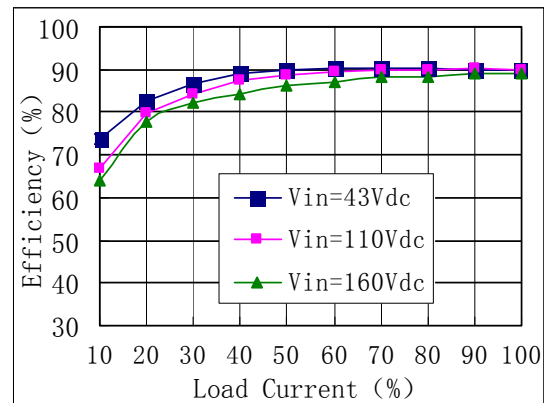

RAHS200-110B24-Y DC-DC Converter

Input 43V~160V, Output 24V/8.33A

Derating Curve 1

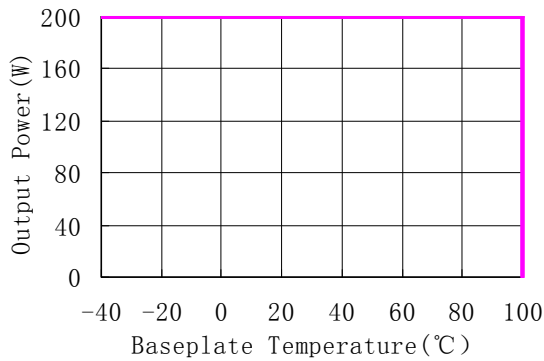

Derating Curve 2

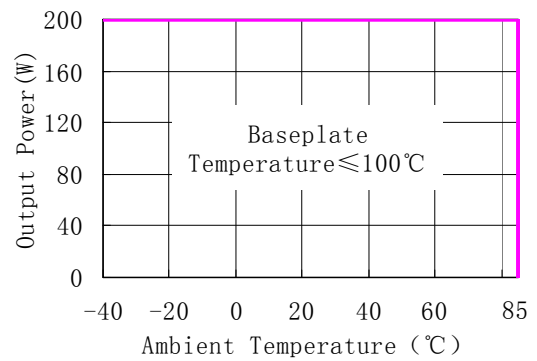

Note: During the converters' installation, attention should be paid to the flow direction of the hot air to ensure the smooth exchange of the heat with the environment. As long as the baseplate temperature does not exceed 100°C, the converters can work normally within the required ambient temperature range. For the specified ambient temperature, users can increase airflow and change the size of heatsink to improve the heat dissipating for the module with baseplate.

Design Considerations

Basic Connection

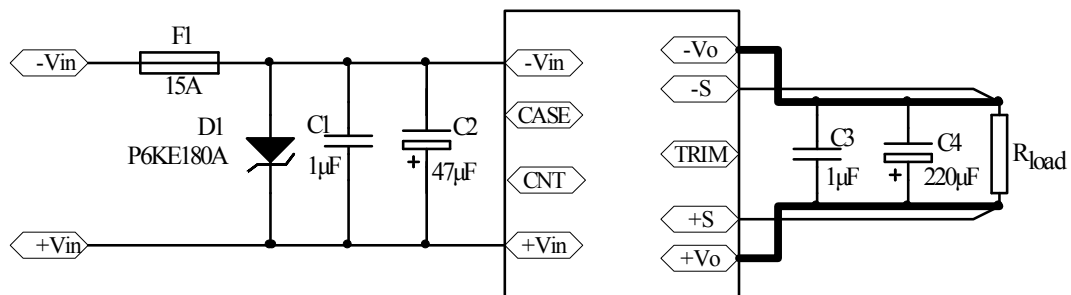

Notes: The basic connection indicates the basic requirements. Please refer to the instruction followed for further information.

Input Voltage Range

The input voltage range of the DC/DC converter is 43V~160V. The input impedance of the converter looks like a negative resistor, which can interact with the reactance of the power bus (including any filter elements that have been added to the input of the converter), causes an unstable condition. Depending on the internal transformer's impedance, the external impedance usually should not exceed the 10% of the internal. So, the source impedance of the Power bus should be kept as low as possible.

External Capacitance

Unless special purpose (i.e. prolonging hold-up time, input impedance matching), the recommended input filter's capacitance ranges 47µF~220µF, which not only offers a stable system, and reduces the cost, but also lessens the inrush current when the power supplies.

When larger capacitance is required, a circuit of suppressing the inrush current is recommended when the regulator start-up and a discharge circuit is recommended when the output dropped, ensuring the reliability and safety of other equipments in the system.

RAHS200-110B24-Y DC-DC Converter

Input 43V~160V, Output 24V/8.33A

Remote Control

Remote control can be offered by setting right control voltage level (refer to -Vin pin) to CNT pin. Positive Logic Control: When the level is higher than 3.5V or be left floating, the converter will be on. When the level is less than 1.5V, the converter will be off. The circuit diagram is shown as “ internal circuit diagram for positive logic control”; when low level applied, the CNT source current is less than 1mA, due to VD1 is signal diode, and the logic comparator is semiconductor integrated chip with low resistance to surge. Care should be taken to prevent CNT from surge, A TVS should be used in some cases.

In some applications, extra controls will be designed for the converter in user’s PCB, such as output short circuit protection, over voltage protection, under voltage protection, synchronous control to the converter output voltage, and so on, remote control will give you help. The controls can be achieved by external circuit applied to the CNT pin.

This product is Positive logic control, when signal exceed the range of 3.5V~15V,or the level which can be received has a very narrow range,(such as turn-on between 5.0V~5.5V), the aux. circuit will be required. Please contact us for more information.

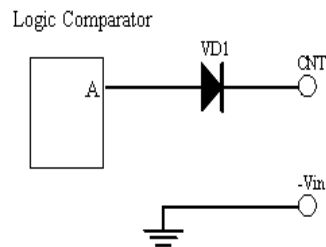

Internal Circuit Diagram For Positive Logic Control

Output Voltage Adjust

The converters have an Output Voltage adjust pin (Trim). This pin can be used to adjust the output voltage above or below Output voltage initial setting. When increasing the output voltage, the voltage at the output pins (including any remote sense offset) must be kept below the maximum output adjust range, or the characteristics will not be assured in compliant with the specification, even the over voltage protection may be triggered. Also note that at increased output voltages the maximum power rating of the converter 200W remains the same, and the output current capability will decrease correspondingly, at decrease output voltages the maximum current should not exceed 8.33 A. When the trim pins are not used, they should be floated.

External circuit is connected as the figure shown, the resistance is calculated as the formula below, please note that the formula will be invalid when $R_{Trim-up}$ 、 $R_{Trim-down}$ are used simultaneously, users adjust the value based on the resistance applied.

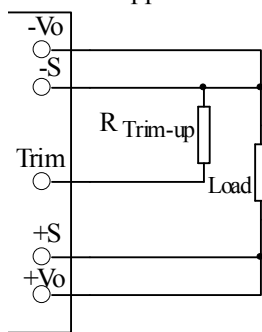

Connection for Trimming Up

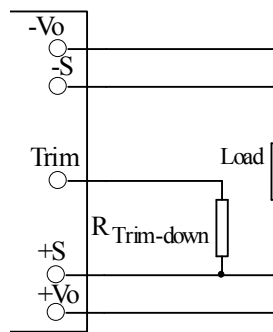

Connection of Trimming Down

Resistance for trimming up : $R_{Trim-up} = \left(\frac{53.75}{\Delta V} - 18 \right) (k\Omega)$

Resistance for trimming down: $R_{Trim-down} = \left(\frac{21.5V_0 - 18\Delta V - 53.75}{\Delta V} \right) (k\Omega)$

Remote Sense

The remote sense can be used to compensate for the voltage drop between the output pins of the converter and the load input pins by +S、-S pins. The +S and -S pins should be connected to the input pins of the load respectively. The remote sense circuit will compensate for up to 0.5V drop between the sense voltage and

RAHS200-110B24-Y DC-DC Converter

Input 43V~160V, Output 24V/8.33A

the voltage at the output pins. If the remote sense is not needed, the -S should be connected to -Vo and +S should be connected to +Vo.

The anti-interference design should be considered when the +S、-S pins are connected to the pins to be compensated. The +S、-S traces should be located close to a ground trace or ground plane, and the area they surrounded should be minimized (just for electrical isolation); If cable connection presents, twisted pair wires should be used, EMI core are equipped with the twisted pair wires to reduce common mode noise when necessary, the sense leads should not be longer than 200mm, or the system characteristics may not be assured.

The sense leads only can carry very little current, and are not used for converter power output. Care should be taken in operation to avoid damaging the converter.

Output Over Voltage Protection(OVP)

The clamp type over voltage protection feature is used to protect the converter, when output voltage exceeds 120% to140% of the rated output voltage (the set point is between 120%~140%, there is the difference based on the specific parameters, but not beyond the range), the output voltage will clamped.

EMC Solution

Recommendation circuit for EMI Conducted emission、Fast transient/burst immunity、Surge immunity.

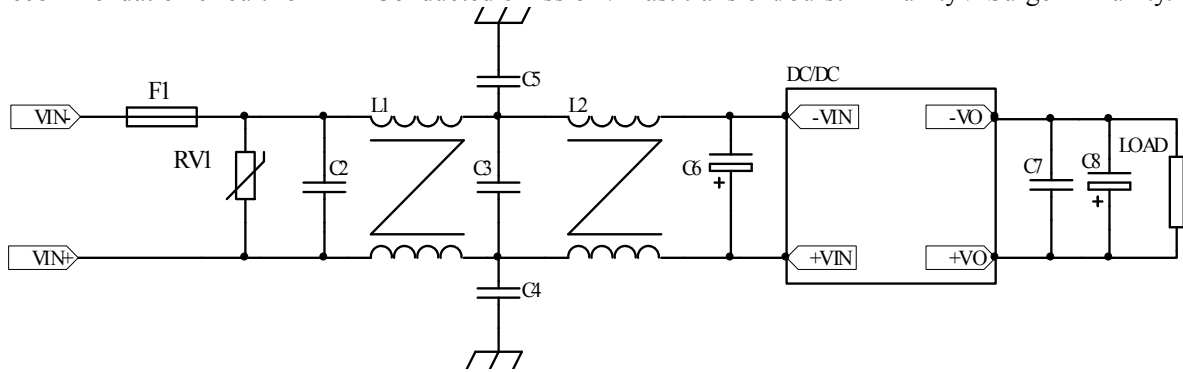

Part No.	Components	Part No.	Components
F1	15A	L1	0.7mH Common Mode Inductors
RV1	221KD14	L2	30mH Common Mode Inductor
C2	>200V, 1μF	C6	>200V, 220μF
C3	>200V, 1μF	C7	1μF/50V ceramic capacitor
C4、C5	>1500Vac, 1nF	C8	220μF/50V

Thermal Consideration

The loss of the converters in normal operation will be converted into heat which can cause the converters itself to rise in temperature. RAHS200-110B12-Y is provided with Over Temperature Protection Feature. The temperature sensor is located on the aluminum baseplate. The converters will be off when the average temperature of the baseplate is higher than that of the over temperature protection point.

In order to ensure that the converter can work normally at rated power, the client system needs to ensure that the aluminum baseplate temperature is less than 100°C.

When aluminum baseplate temperature is higher than 100°C, the derating curves should be referred or external heat dissipation measures. Forced air cooling or heatsink should be used. The air tunnel should be considered for forced air cooling, to avoid heated air be hindered or forming swirl; when heatsink used, it should be attached the converter closely, through double-side thermal conductivity insulation adhesive or thermal conductivity silicone for heat exchange. It is necessary to select the appropriate radiator according to the heat resistance of the radiator without air cooling.

RAHS200-110B24-Y DC-DC ConverterInput 43V~160V, Output 24V/8.33A

Safety Consideration

The converter, as one component for the end user, should be installed into the equipment, and all the safety considerations are achieved under certain condition. It is required to meet safety requirements in system design for the user.

To avoid fire and be protected when short circuit occurred, it is recommended that a fast blow fuse with rating 2~3 times of converter continuous input peak current is used in series at the input terminal. (Inrush current suppression circuit is required for greater filter capacitance at input terminal, or it will result in the misoperation of the fuse).

Product Installation

The product can be installed in user board, suggest using M3 screw to fix the products in user board, in order to enhance the bearing ability when impact and vibration coming. Note that, when you hammer the product using screws, this product shall be first fixed, again a needle pin welding, prevent strain soldered dot. Moreover the biggest torque of fastening screw cannot exceed 0.6 N.m, otherwise it will likely damage the structural related to studs.

Metal surface of this product structured by aluminum PCB which has good thermal conductivity, mapping the overburden with heat conduction medias or thermal gaskets, then install proper radiator.

Proper radiator and flows through radiator wind will greatly enhance products cooling capacity. when you install radiator, you should be paid attention to the length of the bolt, ensure that has no relevant relatives with the screws fixed on PCB.

ESD Control

The converters are processed and manufactured in an ESD controlled environment and supplied in conductive packaging to prevent ESD damage from occurring before or during shipping. It is essential that they are unpacked and handled using an ESD control procedures. Failure to do so affects the lifetime of the converter.

Cleaning Notice

The converter is suitable for water washing, because it does not have any pockets where water could be trapped long-term. Users should ensure that the drying process is adequate and of sufficient duration to remove all water from the converter after washing, do not power up the unit until it is completely dry.

Delivery Package Information

Package material is multiple wall corrugated, internal material is anti-static foam, it's surface resistance is from $10^5 \Omega$ to $10^{12} \Omega$. Tray capacity: 1×3=3 PCS/box, tray weight: 0.51 kg; carton capacity: 15×3=45 PCS, carton weight: 8.5 kg.

Quality Statement

The converters are manufactured in accordance with ISO-9001 system requirements, in compliant with EN50155, and are monitored 100% by auto-testing system, 100% burn in.

The warranty for the converters is 5-year.

Contact Information

Anhui Hesion Trading Co.,Ltd.
& Beijing Yihongtai Technology Dev.Co.,Ltd

TEL: +86-551-65369069,65369067

Email: alecz@ahhesion.com

Backup:alecz@126.com, www.ahhesionpower.com