

Contents

I A_S-1WC2 Series (Fixed Input,1500V isolated and unregulated dual output)	2
II A_S-2WC2 Series (Fixed Input,1500V isolated and unregulated dual output)	7
III D_S-1WC2 Series (Fixed Input,1500V double isolated and unregulated dual output)	12
IV D_S-2WC2 Series (Fixed Input,1500V double isolated and unregulated dual output)	17
V D_KS-1WC2 Series (Fixed Input,1500V double isolated and unregulated dual output)	22
VI D_KS-2WC2 Series (Fixed Input,1500V double isolated and unregulated dual output)	27

I A_S-1WC2 Series 1.5KV isolated & unregulated dual output

1W DC/DC Converters

Features



- ◆ SIP International Standard Pin
- ◆ Low-Quiescent Current and High Conversion Efficiency
- ◆ Low Ripple Coefficient and Low Noise
- ◆ Built-in Soft-Start Technology
- ◆ 1500Vdc Isolation Voltage
- ◆ Operation Temperature : -40°C to 85°C
- ◆ 100% burn-in and screening
- ◆ Special specifications of products can be designed according to customers' requirements

Applications

A_S-1WC2 series products are specially designed for applications where two sources are isolated from the input power supply in a distributed power system.

The products are applicable to:

- 1)The fluctuation range of input power supply voltage is within $\pm 10\%$;
- 2)Isolation is required between input and output(1500Vdc isolation voltage);
- 3)Occasions with low requirements for the output voltage stability and output ripple-noise.

Product Naming Convention

A XXXX S - 1 W C 2

① ② ③ ④ ⑤ ⑥

- ①Product Series
(1500Vdc Isolation Voltage,Dual Output)
- ②Input Voltage (Nominal Value)
- ③Output Voltage (Nominal Value)
- ④Package(Single Inline Package)
- ⑤Rated Output Power
- ⑥Identification Code

Specifications

Unless otherwise specified, all values are given at room temperature and standard atmosphere pressure, standard input voltage.

Selection Table					
Product Model	Input Voltage (Vdc) range (nominal)	Output Voltage① (Vdc)	Output Current (mA) Max(Full Load)/ Min(Light Load)	Maximum Capacitive Load (μF)②	Efficiency (%.Min/Typ) @ Full Load
A0303S-1WC2	2.97~3.63 (3.3V)	±3.3	±152/±15	100	70/74
A0305S-1WC2		±5	±100/±10	100	74/78
A0309S-1WC2		±9	±56/±6	100	74/78
A0312S-1WC2		±12	±42/±5	100	74/78
A0315S-1WC2		±15	±34/±4	100	74/78
A0324S-1WC2		±24	±21/±3	100	74/78
A0503S-1WC2	4.5~5.5 (5V)	±3.3	±152/±15	100	72/76
A0505S-1WC2		±5	±100/±10	100	76/80
A0509S-1WC2		±9	±56/±6	100	76/80
A0512S-1WC2		±12	±42/±5	100	76/80
A0515S-1WC2		±15	±34/±4	100	76/80
A0524S-1WC2		±24	±21/±3	100	76/80

Continue

Selection Table					
Product Model	Input Voltage (Vdc) range (nominal)	Output Voltage ^① (Vdc)	Output Current (mA) Max(Full Load)/ Min(Light Load)	Maximum Capacitive Load (μF) ^②	Efficiency (%.Min/Typ) @ Full Load
A0903S-1WC2	8.1~9.9 (9V)	±3.3	±152/±15	100	72/76
A0905S-1WC2		±5	±100/±10	100	76/80
A0909S-1WC2		±9	±56/±6	100	76/80
A0912S-1WC2		±12	±42/±5	100	76/80
A0915S-1WC2		±15	±34/±4	100	76/80
A0924S-1WC2		±24	±21/±3	100	76/80
A1203S-1WC2	10.8~13.2 (12V)	±3.3	±152/±15	100	72/76
A1205S-1WC2		±5	±100/±10	100	76/80
A1209S-1WC2		±9	±56/±6	100	76/80
A1212S-1WC2		±12	±42/±5	100	76/80
A1215S-1WC2		±15	±34/±4	100	76/80
A1224S-1WC2		±24	±21/±3	100	76/80
A1503S-1WC2	13.5~16.5 (15V)	±3.3	±152/±15	100	76/80
A1505S-1WC2		±5	±100/±10	100	76/80
A1509S-1WC2		±9	±56/±6	100	76/80
A1512S-1WC2		±12	±42/±5	100	76/80
A1515S-1WC2		±15	±34/±4	100	76/80
A1524S-1WC2		±24	±21/±3	100	76/80
A2403S-1WC2	21.6~26.4 (24V)	±3.3	±152/±15	100	76/80
A2405S-1WC2		±5	±100/±10	100	76/80
A2409S-1WC2		±9	±56/±6	100	76/80
A2412S-1WC2		±12	±42/±5	100	76/80
A2415S-1WC2		±15	±34/±4	100	76/80
A2424S-1WC2		±24	±21/±3	100	76/80
AXXXXS-1WC2	Special specifications of products can be designed according to customers' requirements, and 0.1 ~ 1W products can be provided.				
The no-load power consumption of the power modules is about 10% of the rated output power.					
①Nominal output voltage refers to the input voltage in the nominal value and output current under full load conditions.					
②The maximum capacitive load is the maximum capacity of the module power supply to output the capacitive load. Generally, the external output capacitance can not exceed the maximum capacitive load of the module power supply, otherwise, it will result in bad module startup and affect the reliability of the module's long-term work.					

Input Specifications					
Input	Conditions	Min ^③	Typ	Max	Unit
Input Voltage	3.3V Input	-0.7	3.3	5	Vdc
	5V Input	-0.7	5	9	
	9V Input	-0.7	9	15	
	12V Input	-0.7	12	18	
	15V Input	-0.7	15	21	
	24V Input	-0.7	24	30	
③The series of modules have no anti-reverse input protection, the input is strictly prohibited positive and negative reverse, otherwise it will cause irreversible damage to the module.					

Output Specifications						
Output	Conditions		Min	Typ	Max	Unit
Maximum Output Power	—		—	—	1	W
Output Voltage Accuracy	—		See the error envelope diagram			
Linear Voltage Regulation	±1% changes of input voltage	3.3V Output	—	—	±1.5	%
		Other Outputs	—	—	±1.2	
Load Regulation	10%~100% load	3.3V Output	—	18	—	
		5V Output	—	12	—	
		9V Output	—	9	—	
		12V Output	—	8	—	
		15V Output	—	7	—	
		24V Output	—	6	—	
Ripple and Noise④	20MHz bandwidth		—	60	—	mV
Output Short-circuit Protection	—		—	—	1	s

④Ripple and Noise is measured by connecting the oscilloscope probe without ground wire.

General Specifications					
General	Conditions	Min	Typ	Max	Unit
Isolation Voltage	t=60s, leak current≤1mA	1500	—	—	Vdc
Isolation Resistance	Input to Output,500Vdc	1000	—	—	MΩ
Isolation Capacitance	Input to Output 100kHz/0.1V	—	40	—	pF
Operating Temperature	Full-load states of the output voltage	-40	—	+85	°C
Storage Temperature	—	-55	—	+105	°C
Storage Humidity	non condensing	—	—	95	%RH
Temperature Coefficient	100% load	—	—	±0.03	%/°C
Soldering Temperature	1.5 mm distance between solder joint and case, 10s	—	—	300	°C
Switching Frequency	100% load, nominal input voltage	—	100	300	kHz
MTBF	—	3.5×10 ⁶ h Refer to MIL-HDFK-217F@25°C			

Physical Specifications	
Case material	Black flame retardant and heat-resistant epoxy (UL94-V0)
Package Size	19.50mm×10.00mm×6.00mm
Weight	2.4g typ.
Cooling mode	natural air cooling

Characteristic Curves

The Error Envelope Diagram

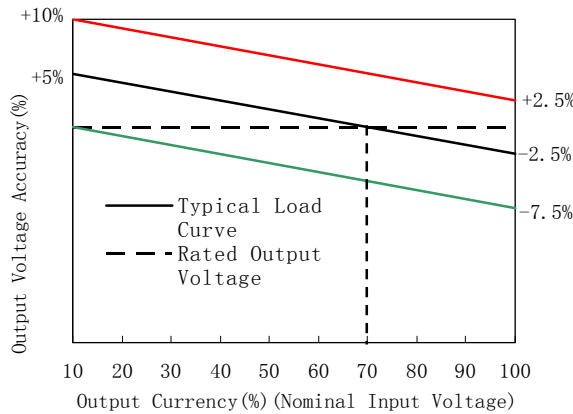

Temperature vs Power

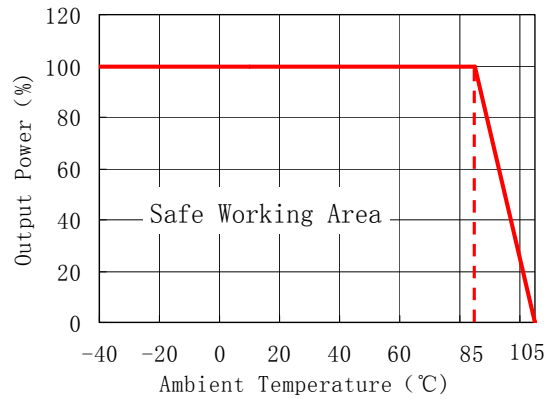

Design Considerations

◆ **Peripheral Recommended Circuit**

Recommended Circuit 1:

A filter capacitor can be connected in parallel at the input and output terminals respectively on the occasions of low requirements for ripple and noise. An external circuit is shown in the figure 1 below. The recommended values of the filter capacitors are shown in the table 1.



The figure 1

The table 1

V _{in} (Vdc)	C _{in}	V _{out} (Vdc)	C _{out}
3.3/5	4.7μF/16V	±3.3/±5	4.7μF/16V
9/12	2.2μF/25V	±9/±12	1μF/25V
15/24	2.2μF/50V	±15/±24	1μF/50V

Recommended Circuit 2:

The external circuit can be referred to the figure 2 on the occasions of strict requirements for ripple and noise. The recommended values of the filter capacitance and inductance are shown in the table 2.

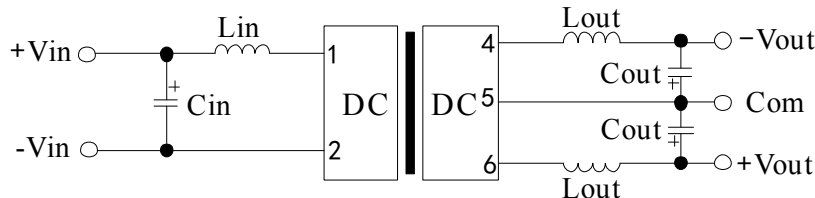

The figure 2

The table 2

V _{in} (Vdc)	C _{in}	L _{in}	C _{out} (Vdc)	L _{out}
3.3/5/9/12/15/24	See the table 1	4.7μH	See the table 1	4.7μH

◆ **Precautions for product use**

- Input requirement: Ensure that the output voltage fluctuations of the power supply do not exceed the input voltage range of the DC/DC module. And the output power of the power supply must be greater than the input power of the DC/DC module.
- Output load requirement: Try to avoid no-load use. When the actual power consumption of the load is less than 10% of the rated power of the module or there is no load, pseudo loads are recommended to be connected at the two outputs respectively. The pseudo load can be calculated from 5 ~ 10% of the rated power of the module, resistance = $V_{out}^2 / (0.5W * 10\%)$.
- Overload protection: Under the normal working conditions, the product has no output overload protection. The simplest approach is to connect a self-recovery fuse in series at the input, or to add a circuit breaker to the circuit.
- The external capacitance of the output terminals should not be too large, otherwise it is easy to cause over-current even failure during starting up of the converter.

Outline Diagram and recommended layout

1) Outline Diagram

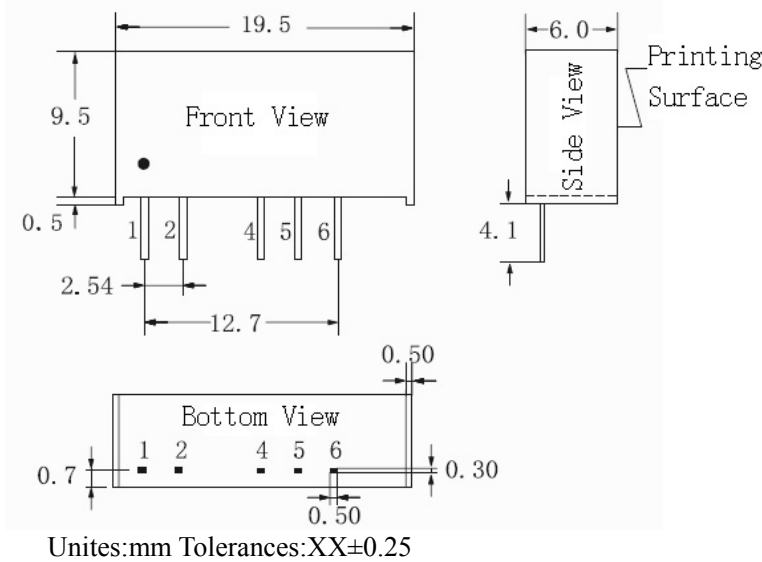

2) Pin Definition

1	+Vin	Positive Input
2	-Vin	Negative Input
3	No Pin	No Pin
4	-Vout	Negative Output
5	Com	Common Ground
6	+Vout	Positive Output

3) Recommended Layout

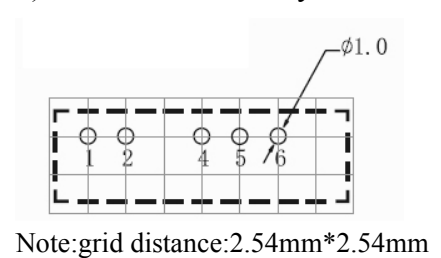

Application Data

Quality Statement

The converters are manufactured in accordance with ISO 9001 system requirements, and are monitored 100% by auto-testing system, 100% burn in. The warranty for the converters is 2-year.

Contact Information

Anhui Hesion Trading Co.,Ltd.
Beijing Yihongtai Technology Dev.Co.,Ltd

TEL: +86-551-65369069,65369067
Email: alecz@ahhesion.com
Backup:alecz@126.com

II A_S-2WC2 Series 1.5KV isolated & unregulated dual output

2W DC/DC Converters



Features

- ◆ SIP International Standard Pin
- ◆ Low-Quiescent Current and High Conversion Efficiency
- ◆ Low Ripple Coefficient and Low Noise
- ◆ Built-in Soft-Start Technology
- ◆ 1500Vdc Isolation Voltage
- ◆ Operation Temperature: -40°C to 85°C
- ◆ 100% Burn-in and Screening
- ◆ Special specifications of products can be designed according to customers' requirements

Applications

A_S-2WC2 series products are specially designed for applications where two sources are isolated from the input power supply in a distributed power system.

The products are applicable to:

- 1) The fluctuation range of input power supply voltage is within $\pm 10\%$;
- 2) Isolation is required between input and output (1500Vdc isolation voltage);
- 3) Occasions with low requirements for the output voltage stability and output ripple-noise.

Product Naming Convention

AXXXXS-2WC2

① ② ③ ④ ⑤ ⑥

- ① Product Series
(1500Vdc Isolation Voltage, Dual Output)
- ② Input Voltage (Nominal Value)
- ③ Output Voltage (Nominal Value)
- ④ Package (Single Inline Package)
- ⑤ Rated Output Power
- ⑥ Identification Code

Specifications

Unless otherwise specified, all values are given at room temperature and standard atmosphere pressure, standard input voltage.

Selection Table					
Product Model	Input Voltage (Vdc) range (nominal)	Output Voltage① (Vdc)	Output Current (mA) Max(Full Load) / Min(Light Load)	Maximum Capacitive Load (μF)②	Efficiency (% ,Min/Typ) @ Full Load
A0303S-2WC2	2.97~3.63 (3.3V)	±3.3	±303/±30	100	72/76
A0305S-2WC2		±5	±200/±20	100	76/80
A0309S-2WC2		±9	±112/±12	100	82/86
A0312S-2WC2		±12	±83/±8	100	82/86
A0315S-2WC2		±15	±67/±7	100	82/86
A0324S-2WC2		±24	±42/±4	100	82/86
A0503S-2WC2	4.5~5.5 (5V)	±3.3	±303/±30	100	72/76
A0505S-2WC2		±5	±200/±20	100	76/80
A0509S-2WC2		±9	±112/±12	100	82/86
A0512S-2WC2		±12	±83/±8	100	82/86
A0515S-2WC2		±15	±67/±7	100	82/86
A0524S-2WC2		±24	±42/±4	100	82/86

Continue

Selection Table					
Product Model	Input Voltage (Vdc) range (nominal)	Output Voltage ^① (Vdc)	Output Current (mA) Max(Full Load)/ Min(Light Load)	Maximum Capacitive Load (μF) ^②	Efficiency (% ,Min/Typ) @ Full Load
A0903S-2WC2	8.1~9.9 (9V)	±3.3	±303/±30	100	78/82
A0905S-2WC2		±5	±200/±20	100	82/86
A0909S-2WC2		±9	±112/±12	100	82/86
A0912S-2WC2		±12	±83/±8	100	82/86
A0915S-2WC2		±15	±67/±7	100	82/86
A0924S-2WC2		±24	±42/±4	100	82/86
A1203S-2WC2	10.8~13.2 (12V)	±3.3	±303/±30	100	72/82
A1205S-2WC2		±5	±200/±20	100	82/86
A1209S-2WC2		±9	±112/±12	100	82/86
A1212S-2WC2		±12	±83/±8	100	82/86
A1215S-2WC2		±15	±67/±7	100	82/86
A1224S-2WC2		±24	±42/±4	100	82/86
A1503S-2WC2	13.5~16.5 (15V)	±3.3	±303/±30	100	78/82
A1505S-2WC2		±5	±200/±20	100	82/86
A1509S-2WC2		±9	±112/±12	100	82/86
A1512S-2WC2		±12	±83/±8	100	82/86
A1515S-2WC2		±15	±67/±7	100	82/86
A1524S-2WC2		±24	±42/±4	100	82/86
A2403S-2WC2	21.6~26.4 (24V)	±3.3	±303/±30	100	78/82
A2405S-2WC2		±5	±200/±20	100	82/86
A2409S-2WC2		±9	±112/±12	100	82/86
A2412S-2WC2		±12	±83/±8	100	82/86
A2415S-2WC2		±15	±67/±7	100	82/86
A2424S-2WC2		±24	±42/±4	100	83/87
AXXXXS-2WC2	Special specifications of products can be designed according to customers' requirements, and 1 ~ 2W products can be provided.				

The no-load power consumption of the power modules is about 10% of the rated output power.
 ①Nominal output voltage refers to the input voltage in the nominal value and output current under full load conditions.
 ②The maximum capacitive load is the maximum capacity of the module power supply to output the capacitive load. Generally, the external output capacitance can not exceed the maximum capacitive load of the module power supply, otherwise, it will result in bad module startup and affect the reliability of the module's long-term work.

Input Specifications					
Input	Conditions	Min ^③	Typ	Max	Unit
Input Voltage	3.3V Input	-0.7	3.3	5	Vdc
	5V Input	-0.7	5	9	
	9V Input	-0.7	9	15	
	12V Input	-0.7	12	18	
	15V Input	-0.7	15	21	
	24V Input	-0.7	24	30	

③The series of modules have no anti-reverse input protection, the input is strictly prohibited positive and negative reverse, otherwise it will cause irreversible damage to the module.

Output Specifications						
Output	Conditions	Min	Typ	Max	Unit	
Maximum Output Power	—	—	—	2	W	
Output Voltage Accuracy	—	See the error envelope diagram				
Linear Voltage Regulation	±1% Changes of input voltage	3.3V Output	—	—	±1.5	%
		Other Outputs	—	—	±1.2	
Load Regulation	10%~100% load	3.3V Output	—	18	—	
		5V Output	—	12	—	
		9V Output	—	8	—	
		12V Output	—	7	—	
		15V Output	—	6	—	
24V Output	—	5	—			
Ripple and Noise④	20MHz bandwidth	—	60	—	mV	
Output Short-circuit Protection	—	—	—	1	s	

④Ripple and Noise is measured by connecting the oscilloscope probe without ground wire.

General Specifications					
General	Conditions	Min	Typ	Max	Unit
Isolation Voltage	t=60s, leak current≤1mA	1500	—	—	Vdc
Isolation Resistance	Input to Output,500Vdc	1000	—	—	MΩ
Isolation Capacitance	Input to Output 100kHz/0.1V	—	40	—	pF
Operating Temperature	Full-load states of the output voltage	-40	—	+85	°C
Storage Temperature	—	-55	—	+105	°C
Storage Humidity	non condensing	—	—	95	%RH
Temperature Coefficient	100% load	—	—	±0.03	%/°C
Soldering Temperature	1.5 mm distance between solder joint and case, 10s	—	—	300	°C
Switching Frequency	100% load, nominal input voltage	—	100	300	kHz
MTBF	—	3.5×10 ⁶ h Refer to MIL-HDFK-217F@25°C			

Physical Specifications	
Case material	Black flame retardant and heat-resistant epoxy (UL94-V0)
Package Size	19.50mm×10.00mm×7.00mm
Weight	2.4g typ.
Cooling mode	natural air cooling

Characteristic Curves

The Error Envelope Diagram

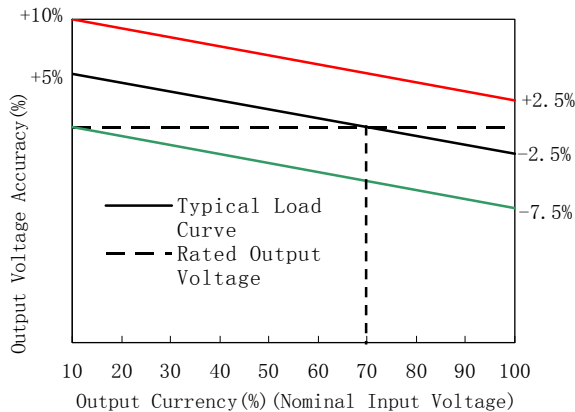

Temperature vs Power

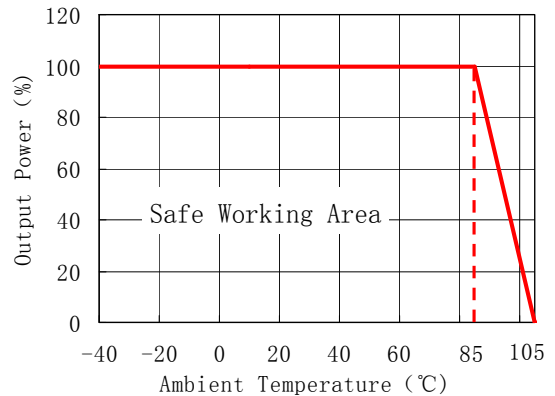

Design Considerations

◆ Peripheral Recommended Circuit

Recommended Circuit 1:

A filter capacitor can be connected in parallel at the input and output terminals respectively on the occasions of low requirements for ripple and noise. An external circuit is shown in the figure 1 below. The recommended values of the filter capacitors are shown in the table 1.

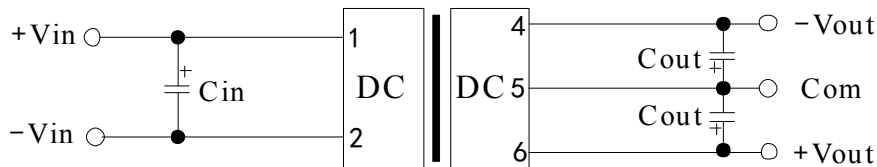

The figure 1

The table 1

Vin(Vdc)	Cin	Vout(Vdc)	Cout
3.3/5	4.7 μ F/16V	\pm 3.3/ \pm 5	4.7 μ F/16V
9/12	2.2 μ F/25V	\pm 9/ \pm 12	1 μ F/25V
15/24	2.2 μ F/50V	\pm 15/ \pm 24	0.47 μ F/50V

Recommended Circuit 2:

The external circuit can be referred to the figure 2 on the occasions of strict requirements for ripple and noise. The recommended values of the filter capacitance and inductance are shown in the table 2.

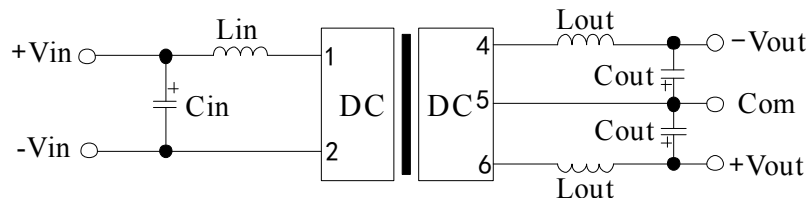

The figure 2

The table 2

Vin(Vdc)	Cin	Lin	Cout (Vdc)	Lout
3.3/5/9/12/15/24	See the table 1	4.7 μ H	See the table 1	4.7 μ H

◆ **Precautions for product use**

- Input requirement: Ensure that the output voltage fluctuations of the power supply do not exceed the input voltage range of the DC/DC module. And the output power of the power supply must be greater than the input power of the DC/DC module.
- Output load requirement: Try to avoid no-load use. When the actual power consumption of the load is less than 10% of the rated power of the module or there is no load, pseudo loads are recommended to be connected at the two outputs respectively. The pseudo load can be calculated from 5 ~ 10% of the rated power of the module, resistance = $V_{out}^2 / (1W * 10\%)$.
- Overload protection: Under the normal working conditions, the product has no output overload protection. The simplest approach is to connect a self-recovery fuse in series at the input, or to add a circuit breaker to the circuit.
- The external capacitance of the output terminals should not be too large, otherwise it is easy to cause over-current even failure during starting up of the converter.

Outline Diagram and recommended layout

1) Outline Diagram

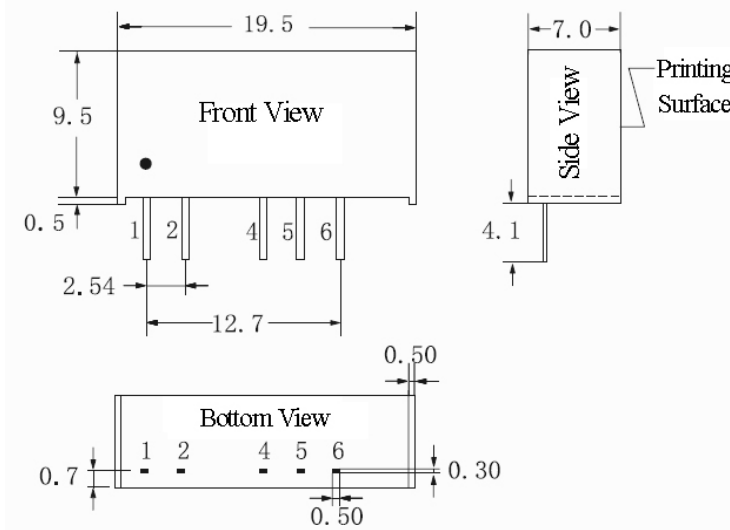

Unites:mm Tolerances:XX±0.25

2) Pin Definition

1	+Vin	Positive Input
2	-Vin	Negative Input
3	No Pin	No Pin
4	-Vout	Negative Output
5	Com	Common Ground
6	+Vout	Positive Output

3) Recommended Layout

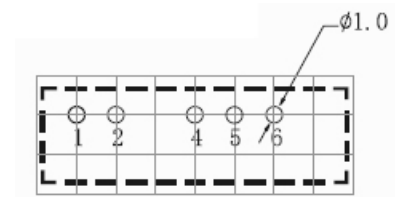

Note: grid distance: 2.54mm*2.54mm

Application Data

Quality Statement

The converters are manufactured in accordance with ISO 9001 system requirements, and are monitored 100% by auto-testing system, 100% burn in. The warranty for the converters is 2-year.

Contact Information

Anhui Hesion Trading Co.,Ltd.
Beijing Yihongtai Technology Dev.Co.,Ltd

TEL: +86-551-65369069,65369067

Email: alecz@ahhesion.com

Backup: alecz@126.com

III D_S-1WC2 Series 1.5KV double isolated & unregulated dual output

1W DC/DC Converters

Features



- ◆ SIP International Standard Pin
- ◆ Low-Quiescent Current and High Conversion Efficiency
- ◆ Low Ripple Coefficient and Low Noise
- ◆ Built-in Soft-Start Technology
- ◆ 1500Vdc Isolation Voltage
- ◆ Operation Temperature:-40°C to 85°C
- ◆ 100% Burn-in and Screening
- ◆ Special specifications of products can be designed according to customers' requirements

Applications

Product Naming Convention

D_S-1WC2 series products are specially designed for applications where two sources are isolated from the input power supply in a distributed power system.

D X X X X X S - 1 W C 2

The products are applicable to:

- 1)The fluctuation range of input power supply voltage is within ± 10%;
- 2)Isolation is required between input and output(1500Vdc isolation voltage);
- 3)Occasions with low requirements for the output voltage stability and output ripple-noise.

- ①Product Series
(1500Vdc Double Isolation ,Dual Output)
- ②Input Voltage (Nominal Value)
- ③Output Voltage 1 (Nominal Value)
- ④Output Voltage 2 (Nominal Value)
- ⑤Package(Single Inline Package)
- ⑥Rated Output Power
- ⑦Identification Code

Specifications

Unless otherwise specified, all values are given at room temperature and standard atmosphere pressure, standard input voltage.

Selection Table						
Product Model	Input Voltage (Vdc) range (nominal)	Output Voltage① (Vdc)	Output Current (mA)		Maximum Capacitive Load (μF)②	Efficiency (% ,Min/Typ) @ Full Load
			Max(Full Load)	Min(Light Load)		
D030303S-1WC2	2.97~3.63 (3.3V)	3.3/3.3	152/152	15/15	100	70/74
D030505S-1WC2		5/5	100/100	10/10	100	74/78
D030909S-1WC2		9/9	56/56	6/6	100	74/78
D031212S-1WC2		12/12	42/42	5/5	100	74/78
D031515S-1WC2		15/15	34/34	4/4	100	74/78
D032424S-1WC2		24/24	21/21	3/3	100	74/78
D050303S-1WC2	4.5~5.5 (5V)	3.3/3.3	152/152	15/15	100	72/76
D050505S-1WC2		5/5	100/100	10/10	100	76/80
D050909S-1WC2		9/9	56/56	6/6	100	76/80
D051212S-1WC2		12/12	42/42	5/5	100	76/80
D051515S-1WC2		15/15	34/34	4/4	100	76/80
D052424S-1WC2		24/24	21/21	3/3	100	76/80

Continue

Selection Table						
Product Model	Input Voltage (Vdc) range (nominal)	Output Voltage ^① (Vdc)	Output Current (mA)		Output Current (mA)	Efficiency (% ,Min/Typ) @ Full Load
			Max(Full Load)	Max(Full Load)		
D090303S-1WC2	8.1~9.9 (9V)	3.3/3.3	152/152	15/15	100	72/76
D090505S-1WC2		5/5	100/100	10/10	100	76/80
D090909S-1WC2		9/9	56/56	6/6	100	76/80
D091212S-1WC2		12/12	42/42	5/5	100	76/80
D091515S-1WC2		15/15	34/34	4/4	100	76/80
D092424S-1WC2		24/24	21/21	3/3	100	76/80
D120303S-1WC2	10.8~13.2 (12V)	3.3/3.3	152/152	15/15	100	72/76
D120505S-1WC2		5/5	100/100	10/10	100	76/80
D120909S-1WC2		9/9	56/56	6/6	100	76/80
D121212S-1WC2		12/12	42/42	5/5	100	76/80
D121515S-1WC2		15/15	34/34	4/4	100	76/80
D122424S-1WC2		24/24	21/21	3/3	100	76/80
D150303S-1WC2	13.5~16.5 (15V)	3.3/3.3	152/152	15/15	100	76/80
D150505S-1WC2		5/5	100/100	10/10	100	76/80
D150909S-1WC2		9/9	56/56	6/6	100	76/80
D151212S-1WC2		12/12	42/42	5/5	100	76/80
D151515S-1WC2		15/15	34/34	4/4	100	76/80
D152424S-1WC2		24/24	21/21	3/3	100	76/80
D240303S-1WC2	21.6~26.4 (24V)	3.3/3.3	152/152	15/15	100	76/80
D240505S-1WC2		5/5	100/100	10/10	100	76/80
D240909S-1WC2		9/9	56/56	6/6	100	76/80
D241212S-1WC2		12/12	42/42	5/5	100	76/80
D241515S-1WC2		15/15	34/34	4/4	100	76/80
D242424S-1WC2		24/24	21/21	3/3	100	76/80
DXXXXXS-1WC2	Special specifications of products can be designed according to customers' requirements, and 0.1 ~ 1W products can be provided.					
The no-load power consumption of the power modules is about 10% of the rated output power.						
①Nominal output voltage refers to the input voltage in the nominal value and output current under full load conditions.						
②The maximum capacitive load is the maximum capacity of the module power supply to output the capacitive load. Generally, the external output capacitance can not exceed the maximum capacitive load of the module power supply, otherwise, it will result in bad module startup and affect the reliability of the module's long-term work.						

Input Specifications					
Input	Conditions	Min ^③	Typ	Max	Unit
Input Voltage	3.3V Input	-0.7	3.3	5	Vdc
	5V Input	-0.7	5	9	
	9V Input	-0.7	9	15	
	12V Input	-0.7	12	18	
	15V Input	-0.7	15	21	
	24V Input	-0.7	24	30	
③The series of modules have no anti-reverse input protection, the input is strictly prohibited positive and negative reverse, otherwise it will cause irreversible damage to the module.					

Output Specifications						
Output	Conditions		Min	Typ	Max	Unit
Maximum Output Power	—		—	—	1	W
Output Voltage Accuracy	—		See the error envelope diagram			
Linear Voltage Regulation	±1% Changes of input voltage	3.3V Output	—	—	±1.5	%
		Other Outputs	—	—	±1.2	
Load Regulation	10%~ 100% load	3.3V Output	—	15	18	
		5V Output	—	12.8	15	
		9V Output	—	8.3	15	
		12V Output	—	6.8	15	
		15V Output	—	6.3	15	
		24V Output	—	6	15	
Ripple and Noise④	20MHz bandwidth		—	60	—	mV
Output Short-circuit Protection	—		—	—	1	s

④Ripple and Noise is measured by connecting the oscilloscope probe without ground wire.

General Specifications						
General	Conditions		Min	Typ	Max	Unit
Isolation Voltage	Vin/Vout	t=60s, leak current≤1mA	1500	—	—	Vdc
	Vo1/Vo2		1000	—	—	Vdc
Isolation Resistance	Input to Output,500Vdc		1000	—	—	MΩ
Isolation Capacitance	Input to Output 100kHz/0.1V		—	40	—	pF
Operating Temperature	Full-load states of the output voltage		-40	—	+85	°C
Storage Temperature	—		-55	—	+105	°C
Storage Humidity	non condensing		—	—	95	%RH
Temperature Coefficient	100% load		—	—	±0.03	%/°C
Soldering Temperature	1.5 mm distance between solder joint and case, 10s		—	—	300	°C
Switching Frequency	100% load, nominal input voltage		—	100	300	kHz
MTBF	—		3.5×10 ⁶ h Refer to MIL-HDFK-217F@25°C			

Physical Specifications	
Case material	Black flame retardant and heat-resistant epoxy (UL94-V0)
Package Size	19.50mm×10.00mm×6.00mm
Weight	2.4g typ.
Cooling mode	natural air cooling

Characteristic Curves

The Error Envelope Diagram

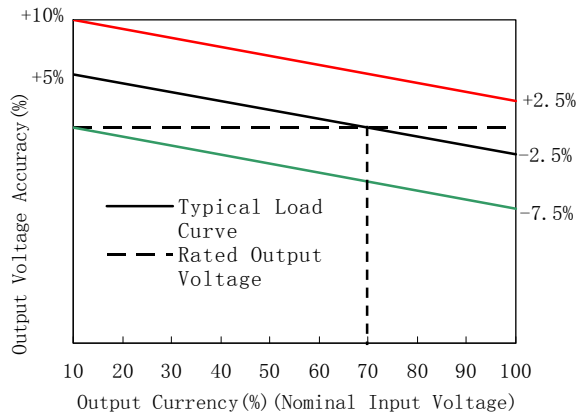

Temperature vs Power

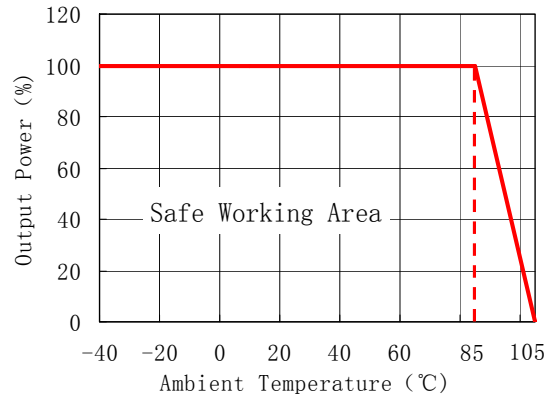

Design Considerations

◆ **Peripheral Recommended Circuit**

Recommended Circuit 1:

A filter capacitor can be connected in parallel at the input and output terminals respectively on the occasions of low requirements for ripple and noise. An external circuit is shown in the figure 1 below. The recommended values of the filter capacitors are shown in the table 1.



The figure 1

The table 1

Vin(Vdc)	Cin	Vout(Vdc)	Cout
3.3/5	4.7 μ F/16V	3.3/5	4.7 μ F/16V
9/12	2.2 μ F/25V	9/12	1 μ F/25V
15/24	2.2 μ F/50V	15/24	1 μ F/50V

Recommended Circuit 2:

The external circuit can be referred to the figure 2 on the occasions of strict requirements for ripple and noise. The recommended values of the filter capacitance and inductance are shown in the table 2.

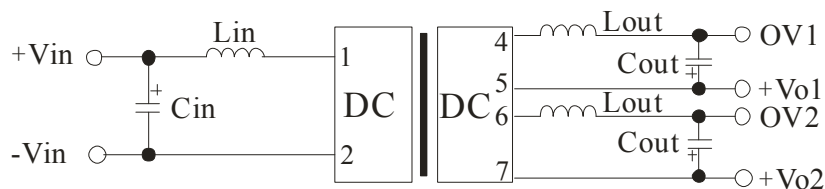

The figure 2

The table 2

Vin(Vdc)	Cin	Lin	Cout (Vdc)	Lout
3.3/5/9/12/15/24	See the table 1	4.7 μ H	See the table 1	4.7 μ H

◆ **Precautions for product use**

- Input requirement: Ensure that the output voltage fluctuations of the power supply do not exceed the input voltage range of the DC/DC module. And the output power of the power supply must be greater than the input power of the DC/DC module.
- Output load requirement: Try to avoid no-load use. When the actual power consumption of the load is less than 10% of the rated power of the module or there is no load, pseudo loads are recommended to be connected at the two outputs respectively. The pseudo load can be calculated from 5 ~ 10% of the rated power of the module, resistance = $V_{out}^2 / (0.5W * 10\%)$.
- Overload protection: Under the normal working conditions, the product has no output overload protection. The simplest approach is to connect a self-recovery fuse in series at the input, or to add a circuit breaker to the circuit.
- The external capacitance of the output terminals should not be too large, otherwise it is easy to cause over-current even failure during starting up of the converter.

Outline Diagram and recommended layout

1) Outline Diagram

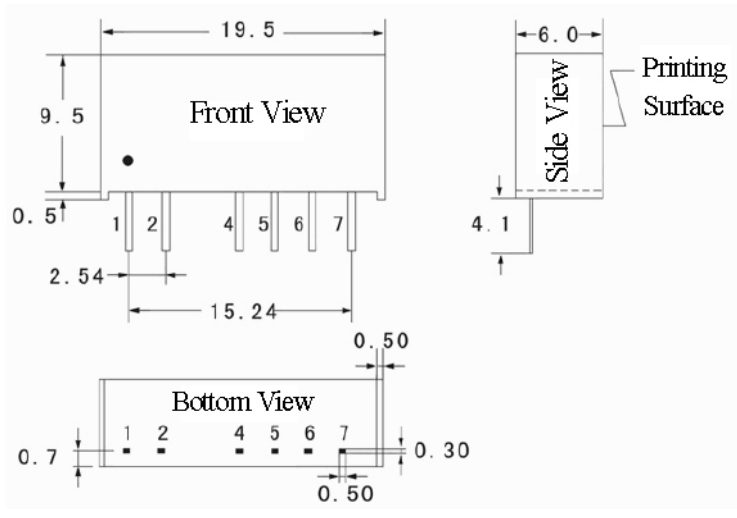

Unites:mm Tolerances:XX±0.25

2) Pin Definition

1	+Vin	Positive Input
2	-Vin	Negative Input
4	OV1	Output Ground 1
5	+Vo1	Positive Output 1
6	OV2	Output Ground 2
7	+Vo2	Positive Output 2

3) Recommended Layout

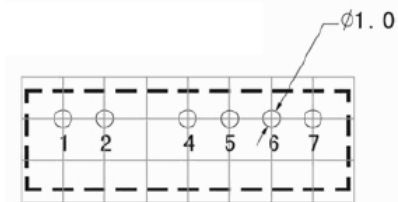

Note:grid distance:2.54mm*2.54mm

Application Data

Quality Statement

The converters are manufactured in accordance with ISO 9001 system requirements, and are monitored 100% by auto-testing system, 100% burn in. The warranty for the converters is 2-year.

Contact Information

Anhui Hesion Trading Co.,Ltd.
Beijing Yihongtai Technology Dev.Co.,Ltd

TEL: +86-551-65369069,65369067
Email: alecz@ahhesion.com
Backup:alecz@126.com

IV D_S-2WC2 Series 1.5KV double isolated & unregulated dual output

2W DC/DC Converters



Features

- ◆ SIP International Standard Pin
- ◆ Low-Quiescent Current and High Conversion Efficiency
- ◆ Low Ripple Coefficient and Low Noise
- ◆ Built-in Soft-Start Technology
- ◆ 1500Vdc Isolation Voltage
- ◆ Operation Temperature:-40°C to 85°C
- ◆ 100% Burn-in and Screening
- ◆ Special specifications of products can be designed according to customers' requirements

Applications

D_S-2WC2 series products are specially designed for applications where two sources are isolated from the input power supply in a distributed power system.

The products are applicable to:

- 1)The fluctuation range of input power supply voltage is within $\pm 10\%$;
- 2)Isolation is required between input and output(1500Vdc isolation voltage);
- 3)Occasions with low requirements for the output voltage stability and output ripple-noise.

Product Naming Convention

DXXXXXXS-2WC2

① ② ③ ④ ⑤ ⑥ ⑦

- ①Product Series
(1500Vdc Double Isolation ,Dual Output)
- ②Input Voltage (Nominal Value)
- ③Output Voltage 1 (Nominal Value)
- ④Output Voltage 2 (Nominal Value)
- ⑤Package(Single Inline Package)
- ⑥Rated Output Power
- ⑦Identification Code

Specifications

Unless otherwise specified, all values are given at room temperature and standard atmosphere pressure, standard input voltage.

Selection Table						
Product Model	Input Voltage (Vdc) range (nominal)	Output Voltage① (Vdc)	Output Current (mA)		Maximum Capacitive Load (μF)②	Efficiency (% ,Min/Typ) @ Full Load
			Max(Full Load)	Min(Light Load)		
D030303S-2WC2	2.97~3.63 (3.3V)	3.3/3.3	303/303	30/30	100	72/76
D030505S-2WC2		5/5	200/200	20/20	100	76/80
D030909S-2WC2		9/9	112/112	12/12	100	82/86
D031212S-2WC2		12/12	83/83	8/8	100	82/86
D031515S-2WC2		15/15	67/67	7/7	100	82/86
D032424S-2WC2		24/24	42/42	4/4	100	82/86
D050303S-2WC2	4.5~5.5 (5V)	3.3/3.3	303/303	30/30	100	72/76
D050505S-2WC2		5/5	200/200	20/20	100	76/80
D050909S-2WC2		9/9	112/112	12/12	100	82/86
D051212S-2WC2		12/12	83/83	8/8	100	82/86
D051515S-2WC2		15/15	67/67	7/7	100	82/86
D052424S-2WC2		24/24	42/42	4/4	100	82/86

Continue

Selection Table						
Product Model	Input Voltage (Vdc) range (nominal)	Output Voltage① (Vdc)	Output Current (mA)		Output Current (mA)	Efficiency (%Min/Typ) @ Full Load
			Max(Full Load)	Min(Light Load)		
D090303S-2WC2	8.1~9.9 (9V)	3.3/3.3	303/303	30/30	100	78/82
D090505S-2WC2		5/5	200/200	20/20	100	82/86
D090909S-2WC2		9/9	112/112	12/12	100	82/86
D091212S-2WC2		12/12	83/83	8/8	100	82/86
D091515S-2WC2		15/15	67/67	7/7	100	82/86
D092424S-2WC2		24/24	42/42	4/4	100	82/86
D120303S-2WC2	10.8~13.2 (12V)	3.3/3.3	303/303	30/30	100	72/82
D120505S-2WC2		5/5	200/200	20/20	100	82/86
D120909S-2WC2		9/9	112/112	12/12	100	82/86
D121212S-2WC2		12/12	83/83	8/8	100	82/86
D121515S-2WC2		15/15	67/67	7/7	100	82/86
D122424S-2WC2		24/24	42/42	4/4	100	82/86
D150303S-2WC2	13.5~16.5 (15V)	3.3/3.3	303/303	30/30	100	78/82
D150505S-2WC2		5/5	200/200	20/20	100	82/86
D150909S-2WC2		9/9	112/112	12/12	100	82/86
D151212S-2WC2		12/12	83/83	8/8	100	82/86
D151515S-2WC2		15/15	67/67	7/7	100	82/86
D152424S-2WC2		24/24	42/42	4/4	100	82/86
D240303S-2WC2	21.6~26.4 (24V)	3.3/3.3	303/303	30/30	100	78/82
D240505S-2WC2		5/5	200/200	20/20	100	82/86
D240909S-2WC2		9/9	112/112	12/12	100	82/86
D241212S-2WC2		12/12	83/83	8/8	100	82/86
D241515S-2WC2		15/15	67/67	7/7	100	82/86
D242424S-2WC2		24/24	42/42	4/4	100	83/87
DXXXXXXS-2WC2	Special specifications of products can be designed according to customers' requirements, and 1 ~ 2W products can be provided.					
The no-load power consumption of the power modules is about 10% of the rated output power.						
①Nominal output voltage refers to the input voltage in the nominal value and output current under full load conditions.						
②The maximum capacitive load is the maximum capacity of the module power supply to output the capacitive load. Generally, the external output capacitance can not exceed the maximum capacitive load of the module power supply, otherwise, it will result in bad module startup and affect the reliability of the module's long-term work.						

Input Specifications					
Input	Conditions	Min③	Typ	Max	Unit
Input Voltage	3.3V Input	-0.7	3.3	5	Vdc
	5V Input	-0.7	5	9	
	9V Input	-0.7	9	15	
	12V Input	-0.7	12	18	
	15V Input	-0.7	15	21	
	24V Input	-0.7	24	30	
③The series of modules have no anti-reverse input protection, the input is strictly prohibited positive and negative reverse, otherwise it will cause irreversible damage to the module.					

Output Specifications						
Output	Conditions		Min	Typ	Max	Unit
Maximum Output Power	—		—	—	2	W
Output Voltage Accuracy	—		See the error envelope diagram			
Linear Voltage Regulation	±1% Changes of input voltage	3.3V Output	—	—	±1.5	%
		Other Outputs	—	—	±1.2	
Load Regulation	10%~ 100% load	3.3V Output	—	15	18	
		5V Output	—	12.8	15	
		9V Output	—	8.3	15	
		12V Output	—	6.8	15	
		15V Output	—	6.3	15	
		24V Output	—	6	15	
Ripple and Noise④	20MHz bandwidth		—	100	150	mV
Output Short-circuit Protection	—		—	—	1	s

④Ripple and Noise is measured by connecting the oscilloscope probe without ground wire.

General Specifications						
General	Conditions		Min	Typ	Max	Unit
Isolation Voltage	Vin/Vout	t=60s, leak current≤1mA	1500	—	—	Vdc
	Vo1/Vo2		1000	—	—	Vdc
Isolation Resistance	Input to Output, 500Vdc		1000	—	—	MΩ
Isolation Capacitance	Input to Output 100kHz/0.1V		—	40	—	pF
Operating Temperature	Full-load states of the output voltage		-40	—	+85	°C
Storage Temperature	—		-55	—	+105	°C
Storage Humidity	Non condensing		—	—	95	%RH
Temperature Coefficient	100% load		—	—	±0.03	%/°C
Soldering Temperature	1.5 mm distance between solder joint and case, 10s		—	—	300	°C
Switching Frequency	100% load, nominal input voltage		—	100	300	kHz
MTBF	—		3.5×10 ⁶ h Refer to MIL-HDFK-217F@25°C			

Physical Specifications	
Case material	Black flame retardant and heat-resistant epoxy (UL94-V0)
Package Size	19.50mm×10.00mm×7.00mm
Weight	2.4g typ.
Cooling mode	natural air cooling

Characteristic Curves

The Error Envelope Diagram

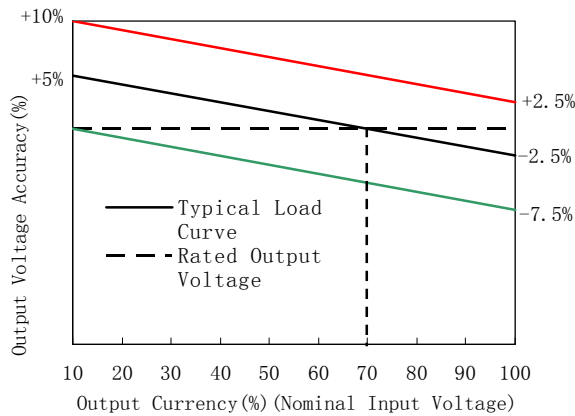

Temperature vs Power

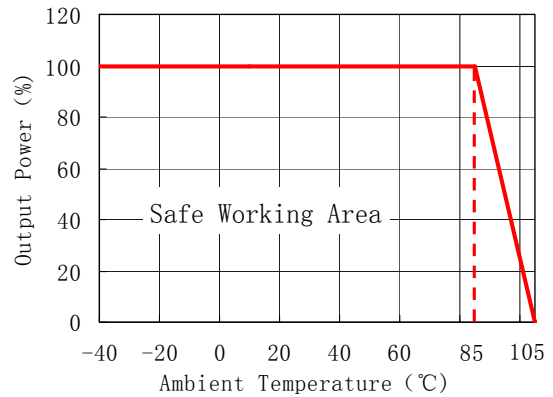

Design Considerations

◆ **Peripheral Recommended Circuit**

Recommended Circuit 1:

A filter capacitor can be connected in parallel at the input and output terminals respectively on the occasions of low requirements for ripple and noise. An external circuit is shown in the figure 1 below. The recommended values of the filter capacitors are shown in the table 1.

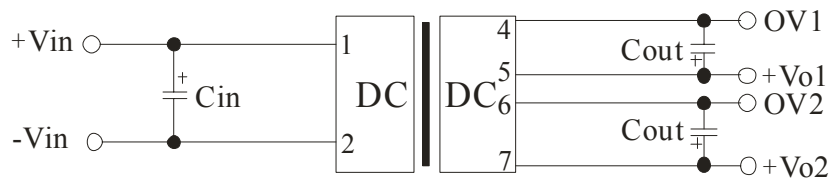

The figure 1

The table 1

Vin(Vdc)	Cin	Vout(Vdc)	Cout
3.3/5	4.7 μ F/16V	3.3/5	4.7 μ F/16V
9/12	2.2 μ F/25V	9/12	1 μ F/25V
15/24	2.2 μ F/50V	15/24	1 μ F/50V

Recommended Circuit 2:

The external circuit can be referred to the figure 2 on the occasions of strict requirements for ripple and noise. The recommended values of the filter capacitance and inductance are shown in the table 2.

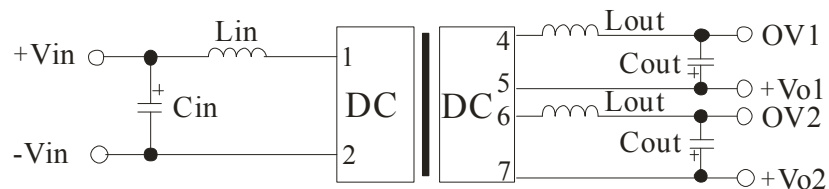

The figure 2

The table 2

Vin(Vdc)	Cin	Lin	Cout (Vdc)	Lout
3.3/5/9/12/15/24	See the table 1	4.7 μ H	See the table 1	4.7 μ H

◆ **Precautions for product use**

- Input requirement: Ensure that the output voltage fluctuations of the power supply do not exceed the input voltage range of the DC/DC module. And the output power of the power supply must be greater than the input power of the DC/DC module.
- Output load requirement: Try to avoid no-load use. When the actual power consumption of the load is less than 10% of the rated power of the module or there is no load, pseudo loads are recommended to be connected at the two outputs respectively. The pseudo load can be calculated from 5 ~ 10% of the rated power of the module, resistance = $V_{out}^2 / (1W * 10\%)$.
- Overload protection: Under the normal working conditions, the product has no output overload protection. The simplest approach is to connect a self-recovery fuse in series at the input, or to add a circuit breaker to the circuit.
- The external capacitance of the output terminals should not be too large, otherwise it is easy to cause over-current even failure during starting up of the converter.

Outline Diagram and recommended layout

1) Outline Diagram

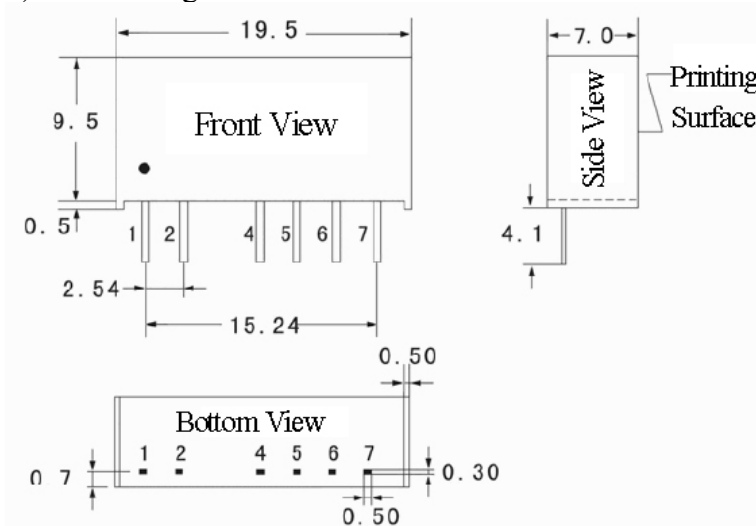

Unites:mm Tolerances:XX±0.25

2) Pin Definition

1	+Vin	Positive Input
2	-Vin	Negative Input
4	OV1	Output Ground 1
5	+Vo1	Positive Output 1
6	OV2	Output Ground 2
7	+Vo2	Positive Output 2

3) Recommended Layout

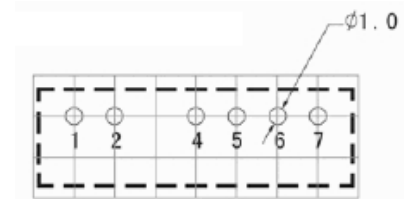

Note: grid distance: 2.54mm*2.54mm

Application Data

Quality Statement

The converters are manufactured in accordance with ISO 9001 system requirements, and are monitored 100% by auto-testing system, 100% burn in. The warranty for the converters is 2-year.

Contact Information

Anhui Hesion Trading Co.,Ltd.
Beijing Yihongtai Technology Dev.Co.,Ltd

TEL: +86-551-65369069,65369067
Email: alecz@ahhesion.com
Backup: alecz@126.com

V D_KS-1WC2 Series 1.5KV double isolated & unregulated dual output

1W DC/DC Converters

Features



- ◆ SIP International Standard Pin
- ◆ Low-Quiescent Current and High Conversion Efficiency
- ◆ Low Ripple Coefficient and Low Noise
- ◆ Built-in Soft-Start Technology
- ◆ 1500Vdc Isolation Voltage
- ◆ Operation Temperature:-40℃ to 85℃
- ◆ 100% Burn-in and Screening
- ◆ Special specifications of products can be designed according to customers' requirements

Applications

Product Naming Convention

D_KS-1WC2 series products are specially designed for applications where two sources are isolated from the input power supply in a distributed power system.

DXXXXXXKS-1WC2

① ② ③ ④ ⑤ ⑥ ⑦

The products are applicable to:

- ①Product Series
(1500Vdc Double Isolation ,Dual Output)
- ②Input Voltage (Nominal Value)
- ③Output Voltage 1 (Nominal Value)
- ④Output Voltage 2 (Nominal Value)
- ⑤Package(Single Inline Package)
- ⑥Rated Output Power
- ⑦Identification Code

- 1)The fluctuation range of input power supply voltage is within $\pm 10\%$;
- 2)Isolation is required between input and output(1500Vdc isolation voltage);
- 3)Occasions with low requirements for the output voltage stability and output ripple-noise.

Specifications

Unless otherwise specified, all values are given at room temperature and standard atmosphere pressure, standard input voltage.

Selection Table						
Product Model	Input Voltage (Vdc) range (nominal)	Output Voltage① (Vdc)	Output Current (mA)		Maximum Capacitive Load (μF)②	Efficiency (% ,Min/Typ) @ Full Load
			Max(Full Load)	Min(Light Load)		
D030303KS-1WC2	2.97~3.63 (3.3V)	3.3/3.3	152/152	15/15	100	70/74
D030505KS-1WC2		5/5	100/100	10/10	100	74/78
D030909KS-1WC2		9/9	56/56	6/6	100	74/78
D031212KS-1WC2		12/12	42/42	5/5	100	74/78
D031515KS-1WC2		15/15	34/34	4/4	100	74/78
D032424KS-1WC2		24/24	21/21	3/3	100	74/78
D050303KS-1WC2	4.5~5.5 (5V)	3.3/3.3	152/152	15/15	100	72/76
D050505KS-1WC2		5/5	100/100	10/10	100	76/80
D050909KS-1WC2		9/9	56/56	6/6	100	76/80
D051212KS-1WC2		12/12	42/42	5/5	100	76/80
D051515KS-1WC2		15/15	34/34	4/4	100	76/80
D052424KS-1WC2		24/24	21/21	3/3	100	76/80

Continue

Selection Table						
Product Model	Input Voltage (Vdc) range (nominal)	Output Voltage① (Vdc)	Output Current (mA)		Maximum Capacitive Load (μF)②	Efficiency (%Min/Typ) @ Full Load
			Max(Full Load)	Min(Light Load)		
D090303KS-1WC2	8.1~9.9 (9V)	3.3/3.3	152/152	15/15	100	72/76
D090505KS-1WC2		5/5	100/100	10/10	100	76/80
D090909KS-1WC2		9/9	56/56	6/6	100	76/80
D091212KS-1WC2		12/12	42/42	5/5	100	76/80
D091515KS-1WC2		15/15	34/34	4/4	100	76/80
D092424KS-1WC2		24/24	21/21	3/3	100	76/80
D120303KS-1WC2	10.8~13.2 (12V)	3.3/3.3	152/152	15/15	100	72/76
D120505KS-1WC2		5/5	100/100	10/10	100	76/80
D120909KS-1WC2		9/9	56/56	6/6	100	76/80
D121212KS-1WC2		12/12	42/42	5/5	100	76/80
D121515KS-1WC2		15/15	34/34	4/4	100	76/80
D122424KS-1WC2		24/24	21/21	3/3	100	76/80
D150303KS-1WC2	13.5~16.5 (15V)	3.3/3.3	152/152	15/15	100	76/80
D150505KS-1WC2		5/5	100/100	10/10	100	76/80
D150909KS-1WC2		9/9	56/56	6/6	100	76/80
D151212KS-1WC2		12/12	42/42	5/5	100	76/80
D151515KS-1WC2		15/15	34/34	4/4	100	76/80
D152424KS-1WC2		24/24	21/21	3/3	100	76/80
D240303KS-1WC2	21.6~26.4 (24V)	3.3/3.3	152/152	15/15	100	76/80
D240505KS-1WC2		5/5	100/100	10/10	100	76/80
D240909KS-1WC2		9/9	56/56	6/6	100	76/80
D241212KS-1WC2		12/12	42/42	5/5	100	76/80
D241515KS-1WC2		15/15	34/34	4/4	100	76/80
D242424KS-1WC2		24/24	21/21	3/3	100	76/80
DXXXXXXKS-1WC2	Special specifications of products can be designed according to customers' requirements, and 0.1 ~ 1W products can be provided.					

The no-load power consumption of the power modules is about 10% of the rated output power.
 ①Nominal output voltage refers to the input voltage in the nominal value and output current under full load conditions.
 ②The maximum capacitive load is the maximum capacity of the module power supply to output the capacitive load. Generally, the external output capacitance can not exceed the maximum capacitive load of the module power supply, otherwise, it will result in bad module startup and affect the reliability of the module's long-term work.

Input Specifications					
Input	Conditions	Min③	Typ	Max	Unit
Input Voltage	3.3V Input	-0.7	3.3	5	Vdc
	5V Input	-0.7	5	9	
	9V Input	-0.7	9	15	
	12V Input	-0.7	12	18	
	15V Input	-0.7	15	21	
	24V Input	-0.7	24	30	
③The series of modules have no anti-reverse input protection, the input is strictly prohibited positive and negative reverse, otherwise it will cause irreversible damage to the module.					

Output Specifications						
Output	Conditions		Min	Typ	Max	Unit
Maximum Output Power	—		—	—	1	W
Output Voltage Accuracy	—		See the error envelope diagram			
Linear Voltage Regulation	±1% changes of input voltage	3.3V Output	—	—	±1.5	%
		Other Outputs	—	—	±1.2	
Load Regulation	10%~100% load	3.3V Output	—	15	18	
		5V Output	—	12.8	15	
		9V Output	—	8.3	15	
		12V Output	—	6.8	15	
		15V Output	—	6.3	15	
		24V Output	—	6	15	
Ripple and Noise④	20MHz bandwidth		—	60	—	mV
Output Short-circuit Protection	—		—	—	1	s

④Ripple and Noise is measured by connecting the oscilloscope probe without ground wire.

General Specifications						
General	Conditions		Min	Typ	Max	Unit
Isolation Voltage	Vin/Vout	t=60s, leak current≤1mA	1500	—	—	Vdc
	Vo1/Vo2		1000	—	—	Vdc
Isolation Resistance	Input to Output,500Vdc		1000	—	—	MΩ
Isolation Capacitance	Input to Output 100kHz/0.1V		—	40	—	pF
Operating Temperature	Full-load states of the output voltage		-40	—	+85	°C
Storage Temperature	—		-55	—	+105	°C
Storage Humidity	non condensing		—	—	95	%RH
Temperature Coefficient	100% load		—	—	±0.03	%/°C
Soldering Temperature	1.5 mm distance between solder joint and case, 10s		—	—	300	°C
Switching Frequency	100% load, nominal input voltage		—	100	300	kHz
MTBF	—		3.5×10 ⁶ h Refer to MIL-HDFK-217F@25°C			

Physical Specifications	
Case material	Black flame retardant and heat-resistant epoxy (UL94-V0)
Package Size	19.50mm×10.00mm×6.00mm
Weight	2.4g typ.
Cooling mode	natural air cooling

Characteristic Curves

The Error Envelope Diagram

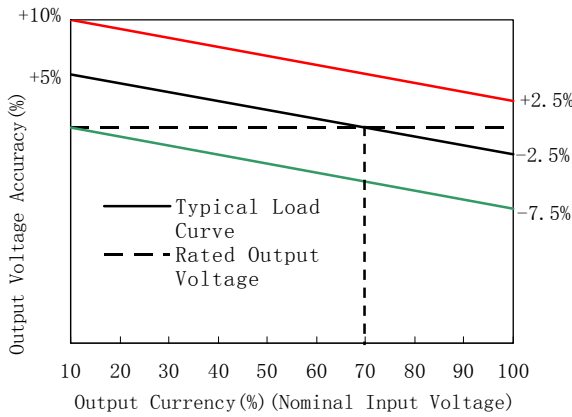

Temperature vs Power

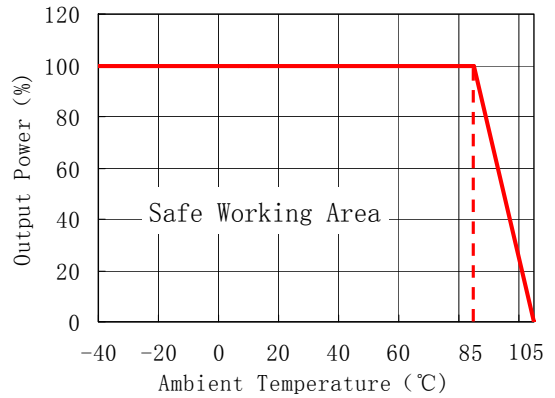

Design Considerations

◆ Peripheral Recommended Circuit

Recommended Circuit 1:

A filter capacitor can be connected in parallel at the input and output terminals respectively on the occasions of low requirements for ripple and noise. An external circuit is shown in the figure 1 below. The recommended values of the filter capacitors are shown in the table 1.

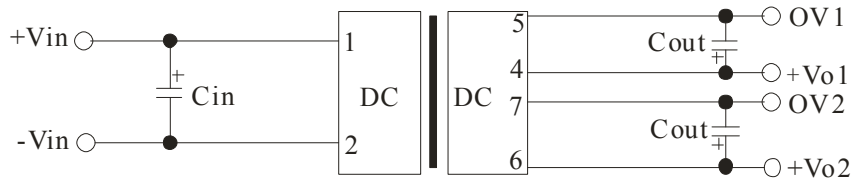

The figure 1

The table 1

Vin(Vdc)	Cin	Vout(Vdc)	Cout
3.3/5	4.7 μ F/16V	3.3/5	4.7 μ F/16V
9/12	2.2 μ F/25V	9/12	1 μ F/25V
15/24	2.2 μ F/50V	15/24	1 μ F/50V

Recommended Circuit 2:

The external circuit can be referred to the figure 2 on the occasions of strict requirements for ripple and noise. The recommended values of the filter capacitance and inductance are shown in the table 2.

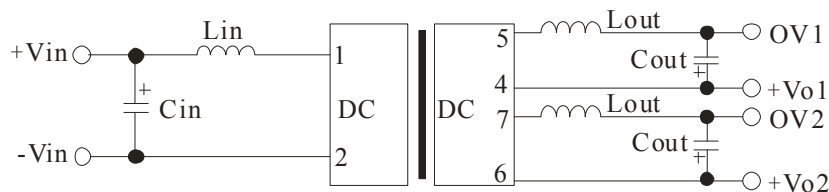

The figure 2

The table 2

Vin(Vdc)	Cin	Lin	Cout (Vdc)	Lout
3.3/5/9/12/15/24	See the table 1	4.7 μ H	See the table 1	4.7 μ H

◆ **Precautions for product use**

- Input requirement: Ensure that the output voltage fluctuations of the power supply do not exceed the input voltage range of the DC/DC module. And the output power of the power supply must be greater than the input power of the DC/DC module.
- Output load requirement: Try to avoid no-load use. When the actual power consumption of the load is less than 10% of the rated power of the module or there is no load, pseudo loads are recommended to be connected at the two outputs respectively. The pseudo load can be calculated from 5 ~ 10% of the rated power of the module, resistance = $V_{out}^2 / (0.5W * 10\%)$.
- Overload protection: Under the normal working conditions, the product has no output overload protection. The simplest approach is to connect a self-recovery fuse in series at the input, or to add a circuit breaker to the circuit.
- The external capacitance of the output terminals should not be too large, otherwise it is easy to cause over-current even failure during starting up of the converter.

Outline Diagram and recommended layout

1) Outline Diagram

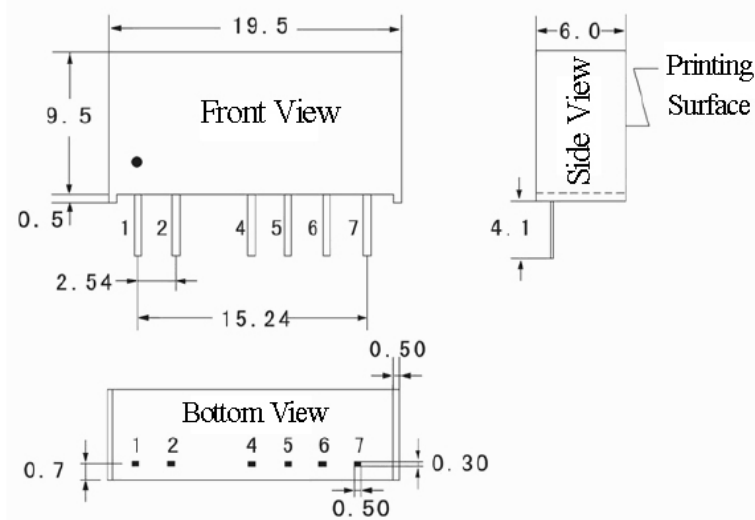

Unites:mm Tolerances:XX±0.25

2) Pin Definition

1	+Vin	Positive Input
2	-Vin	Negative Input
4	+Vo1	Positive Output 1
5	OV1	Output Ground 1
6	+Vo2	Positive Output 2
7	OV2	Output Ground 2

3) Recommended Layout

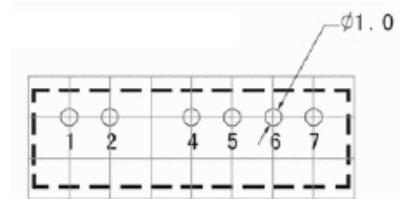

Note: grid distance: 2.54mm*2.54mm

Application Data

Quality Statement

The converters are manufactured in accordance with ISO 9001 system requirements, and are monitored 100% by auto-testing system, 100% burn in. The warranty for the converters is 2-year.

Contact Information

Anhui Hesion Trading Co.,Ltd.
Beijing Yihongtai Technology Dev.Co.,Ltd

TEL: +86-551-65369069,65369067

Email: alecz@ahhesion.com

Backup: alecz@126.com

VI D_KS-2WC2 Series 1.5KV double isolated & unregulated dual output

2W DC/DC Converters Features



- ◆ SIP International Standard Pin
- ◆ Low-Quiescent Current and High Conversion Efficiency
- ◆ Low Ripple Coefficient and Low Noise
- ◆ Built-in Soft-Start Technology
- ◆ 1500Vdc Isolation Voltage
- ◆ Operation Temperature:-40°C to 85°C
- ◆ 100% burn-in and screening
- ◆ Special specifications of products can be designed according to customers' requirements

Applications Product Naming Convention

D_KS-2WC2 series products are specially designed for applications where two sources are isolated from the input power supply in a distributed power system.

The products are applicable to:

- 1)The fluctuation range of input power supply voltage is within $\pm 10\%$;
- 2)Isolation is required between input and output(1500Vdc isolation voltage);
- 3)Occasions with low requirements for the output voltage stability and output ripple–noise.

DXXXXXXKS-2WC2

① ② ③ ④ ⑤ ⑥ ⑦

- ①Product Series
(1500Vdc Double Isolation ,Dual Output)
- ②Input Voltage (Nominal Value)
- ③Output Voltage 1 (Nominal Value)
- ④Output Voltage 2 (Nominal Value)
- ⑤Package(Single Inline Package)
- ⑥Rated Output Power
- ⑦Identification Code

Specifications

Unless otherwise specified, all values are given at room temperature and standard atmosphere pressure, standard input voltage.

Selection Table						
Product Model	Input Voltage (Vdc) range (nominal)	Output Voltage① (Vdc)	Output Current (mA)		Maximum Capacitive Load (μF)②	Efficiency (% ,Min/Typ) @ Full Load
			Max(Full Load)	Min(Light Load)		
D030303KS-2WC2	2.97~3.63 (3.3V)	3.3/3.3	303/303	30/30	100	72/76
D030505KS-2WC2		5/5	200/200	20/20	100	76/80
D030909KS-2WC2		9/9	112/112	12/12	100	82/86
D031212KS-2WC2		12/12	83/83	8/8	100	82/86
D031515KS-2WC2		15/15	67/67	7/7	100	82/86
D032424KS-2WC2		24/24	42/42	4/4	100	82/86
D050303KS-2WC2	4.5~5.5 (5V)	3.3/3.3	303/303	30/30	100	72/76
D050505KS-2WC2		5/5	200/200	20/20	100	76/80
D050909KS-2WC2		9/9	112/112	12/12	100	82/86
D051212KS-2WC2		12/12	83/83	8/8	100	82/86
D051515KS-2WC2		15/15	67/67	7/7	100	82/86
D052424KS-2WC2		24/24	42/42	4/4	100	82/86

Continue

Selection Table						
Product Model	Input Voltage (Vdc) range (nominal)	Output Voltage ^① (Vdc)	Output Current (mA)		Maximum Capacitive Load (μF) ^②	Efficiency (% ,Min/Typ) @ Full Load
			Max(Full Load)	Min(Light Load)		
D090303KS-2WC2	8.1~9.9 (9V)	3.3/3.3	303/303	30/30	100	78/82
D090505KS-2WC2		5/5	200/200	20/20	100	82/86
D090909KS-2WC2		9/9	112/112	12/12	100	82/86
D091212KS-2WC2		12/12	83/83	8/8	100	82/86
D091515KS-2WC2		15/15	67/67	7/7	100	82/86
D092424KS-2WC2		24/24	42/42	4/4	100	82/86
D120303KS-2WC2	10.8~13.2 (12V)	3.3/3.3	303/303	30/30	100	72/82
D120505KS-2WC2		5/5	200/200	20/20	100	82/86
D120909KS-2WC2		9/9	112/112	12/12	100	82/86
D121212KS-2WC2		12/12	83/83	8/8	100	82/86
D121515KS-2WC2		15/15	67/67	7/7	100	82/86
D122424KS-2WC2		24/24	42/42	4/4	100	82/86
D150303KS-2WC2	13.5~16.5 (15V)	3.3/3.3	303/303	30/30	100	78/82
D150505KS-2WC2		5/5	200/200	20/20	100	82/86
D150909KS-2WC2		9/9	112/112	12/12	100	82/86
D151212KS-2WC2		12/12	83/83	8/8	100	82/86
D151515KS-2WC2		15/15	67/67	7/7	100	82/86
D152424KS-2WC2		24/24	42/42	4/4	100	82/86
D240303KS-2WC2	21.6~26.4 (24V)	3.3/3.3	303/303	30/30	100	78/82
D240505KS-2WC2		5/5	200/200	20/20	100	82/86
D240909KS-2WC2		9/9	112/112	12/12	100	82/86
D241212KS-2WC2		12/12	83/83	8/8	100	82/86
D241515KS-2WC2		15/15	67/67	7/7	100	82/86
D242424KS-2WC2		24/24	42/42	4/4	100	83/87
DXXXXXXKS-2WC2	Special specifications of products can be designed according to customers' requirements, and 1 ~ 2W products can be provided.					

The no-load power consumption of the power modules is about 10% of the rated output power.
 ①Nominal output voltage refers to the input voltage in the nominal value and output current under full load conditions.
 ②The maximum capacitive load is the maximum capacity of the module power supply to output the capacitive load. Generally, the external output capacitance can not exceed the maximum capacitive load of the module power supply, otherwise, it will result in bad module startup and affect the reliability of the module's long-term work.

Input Specifications					
Input	Conditions	Min ^③	Typ	Max	Unit
Input Voltage	3.3V Input	-0.7	3.3	5	Vdc
	5V Input	-0.7	5	9	
	9V Input	-0.7	9	15	
	12V Input	-0.7	12	18	
	15V Input	-0.7	15	21	
	24V Input	-0.7	24	30	
③The series of modules have no anti-reverse input protection, the input is strictly prohibited positive and negative reverse, otherwise it will cause irreversible damage to the module.					

Output Specifications						
Output	Conditions		Min	Typ	Max	Unit
Maximum Output Power	—		—	—	2	W
Output Voltage Accuracy	—		See the error envelope diagram			
Linear Voltage Regulation	±1% Changes of input voltage	3.3V Output	—	—	±1.5	%
		Other Outputs	—	—	±1.2	
Load Regulation	10%~100% load	3.3V Output	—	15	18	
		5V Output	—	12.8	15	
		9V Output	—	8.3	15	
		12V Output	—	6.8	15	
		15V Output	—	6.3	15	
24V Output	—	6	15			
Ripple and Noise④	20MHz bandwidth		—	100	150	mV
Output Short-circuit Protection	—		—	—	1	s

④Ripple and Noise is measured by connecting the oscilloscope probe without ground wire.

General Specifications						
General	Conditions		Min	Typ	Max	Unit
Isolation Voltage	Vin/Vout	t=60s, leak current≤1mA	1500	—	—	Vdc
	Vo1/Vo2		1000	—	—	Vdc
Isolation Resistance	Input to Output,500Vdc		1000	—	—	MΩ
Isolation Capacitance	Input to Output 100kHz/0.1V		—	40	—	pF
Operating Temperature	Full-load states of the output voltage		-40	—	+85	°C
Storage Temperature	—		-55	—	+105	°C
Storage Humidity	non condensing		—	—	95	%RH
Temperature Coefficient	100% load		—	—	±0.03	%/°C
Soldering Temperature	1.5 mm distance between solder joint and case, 10s		—	—	300	°C
Switching Frequency	100% load, nominal input voltage		—	100	300	kHz
MTBF	—		3.5×10 ⁶ h Refer to MIL-HDFK-217F@25°C			

Physical Specifications	
Case material	Black flame retardant and heat-resistant epoxy (UL94-V0)
Package Size	19.50mm×10.00mm×7.00mm
Weight	2.4g typ.
Cooling mode	natural air cooling

Characteristic Curves

The Error Envelope Diagram

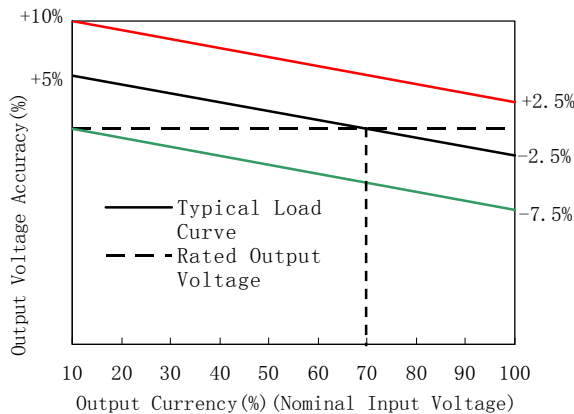

Temperature vs Power

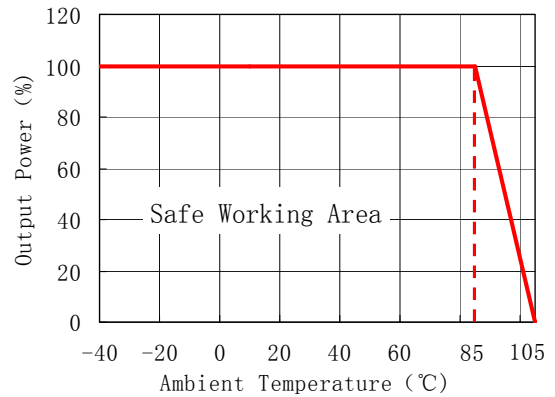

Design Considerations

◆ Peripheral Recommended Circuit

Recommended Circuit 1:

A filter capacitor can be connected in parallel at the input and output terminals respectively on the occasions of low requirements for ripple and noise. An external circuit is shown in the figure 1 below. The recommended values of the filter capacitors are shown in the table 1.



The figure 1

The table 1

Vin(Vdc)	Cin	Vout(Vdc)	Cout
3.3/5	4.7μF/16V	3.3/5	4.7μF/16V
9/12	2.2μF/25V	9/12	1μF/25V
15/24	2.2μF/50V	15/24	1μF/50V

Recommended Circuit 2:

The external circuit can be referred to the figure 2 on the occasions of strict requirements for ripple and noise. The recommended values of the filter capacitance and inductance are shown in the table 2.

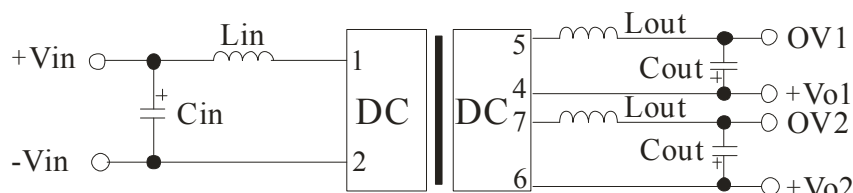

The figure 2

The table 2

Vin(Vdc)	Cin	Lin	Cout (Vdc)	Lout
3.3/5/9/12/15/24	See the table 1	4.7μH	See the table 1	4.7μH

◆ **Precautions for product use**

- Input requirement: Ensure that the output voltage fluctuations of the power supply do not exceed the input voltage range of the DC/DC module. And the output power of the power supply must be greater than the input power of the DC/DC module.
- Output load requirement: Try to avoid no-load use. When the actual power consumption of the load is less than 10% of the rated power of the module or there is no load, pseudo loads are recommended to be connected at the two outputs respectively. The pseudo load can be calculated from 5 ~ 10% of the rated power of the module, resistance = $V_{out}^2 / (1W * 10\%)$.
- Overload protection: Under the normal working conditions, the product has no output overload protection. The simplest approach is to connect a self-recovery fuse in series at the input, or to add a circuit breaker to the circuit.
- The external capacitance of the output terminals should not be too large, otherwise it is easy to cause over-current even failure during starting up of the converter.

Outline Diagram and recommended layout

1) Outline Diagram

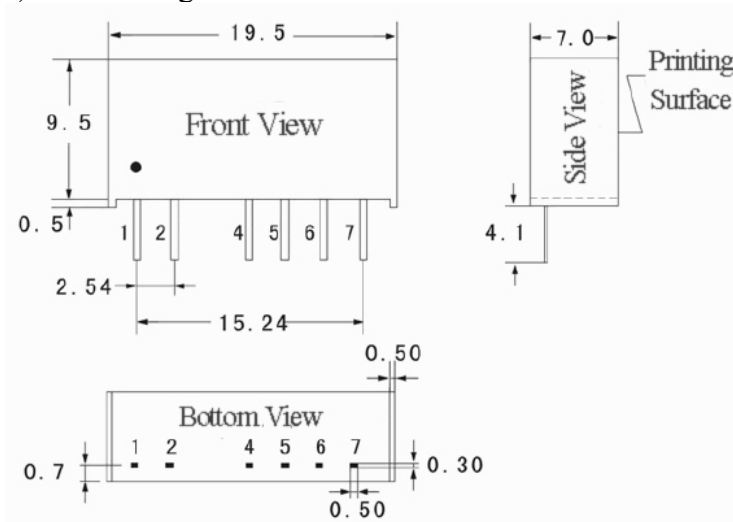

Unites:mm Tolerances:XX±0.25

2) Pin Definition

1	+Vin	Positive Input
2	-Vin	Negative Input
4	+Vo1	Positive Output 1
5	OV1	Output Ground 1
6	+Vo2	Positive Output 2
7	OV2	Output Ground 2

3) Recommended Layout

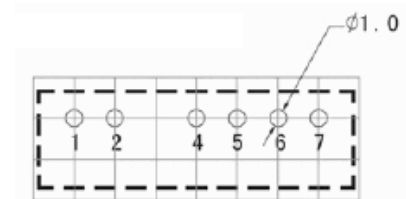

Note: grid distance: 2.54mm*2.54mm

Application Data

Quality Statement

The converters are manufactured in accordance with ISO 9001 system requirements, and are monitored 100% by auto-testing system, 100% burn in. The warranty for the converters is 2-year.

Contact Information

Anhui Hesion Trading Co.,Ltd.
Beijing Yihongtai Technology Dev.Co.,Ltd

TEL: +86-551-65369069,65369067
Email: alecz@ahhesion.com
Backup: alecz@126.com